

User Manual



TSG 95 Pathfinder™ PAL/NTSC Signal Generator

070-8916-06

Copyright © Tektronix, Inc. All rights reserved.

Tektronix products are covered by U.S. and foreign patents, issued and pending. Information in this publication supercedes that in all previously published material. Specifications and price change privileges reserved.

Printed in the U.S.A.

Tektronix, Inc., P.O. Box 1000, Wilsonville, OR 97070-1000

TEKTRONIX and TEK are registered trademarks of Tektronix, Inc.

WARRANTY

Tektronix warrants that the products that it manufactures and sells will be free from defects in materials and workmanship for a period of one (1) year from the date of shipment. If a product proves defective during this warranty period, Tektronix, at its option, either will repair the defective product without charge for parts and labor, or will provide a replacement in exchange for the defective product.

In order to obtain service under this warranty, Customer must notify Tektronix of the defect before the expiration of the warranty period and make suitable arrangements for the performance of service. Customer shall be responsible for packaging and shipping the defective product to the service center designated by Tektronix, with shipping charges prepaid. Tektronix shall pay for the return of the product to Customer if the shipment is to a location within the country in which the Tektronix service center is located. Customer shall be responsible for paying all shipping charges, duties, taxes, and any other charges for products returned to any other locations.

This warranty shall not apply to any defect, failure or damage caused by improper use or improper or inadequate maintenance and care. Tektronix shall not be obligated to furnish service under this warranty a) to repair damage resulting from attempts by personnel other than Tektronix representatives to install, repair or service the product; b) to repair damage resulting from improper use or connection to incompatible equipment; c) to repair any damage or malfunction caused by the use of non-Tektronix supplies; or d) to service a product that has been modified or integrated with other products when the effect of such modification or integration increases the time or difficulty of servicing the product.

THIS WARRANTY IS GIVEN BY TEKTRONIX IN LIEU OF ANY OTHER WARRANTIES, EXPRESS OR IMPLIED. TEKTRONIX AND ITS VENDORS DISCLAIM ANY IMPLIED WARRANTIES OF MERCHANTABILITY OR FITNESS FOR A PARTICULAR PURPOSE. TEKTRONIX' RESPONSIBILITY TO REPAIR OR REPLACE DEFECTIVE PRODUCTS IS THE SOLE AND EXCLUSIVE REMEDY PROVIDED TO THE CUSTOMER FOR BREACH OF THIS WARRANTY. TEKTRONIX AND ITS VENDORS WILL NOT BE LIABLE FOR ANY INDIRECT, SPECIAL, INCIDENTAL, OR CONSEQUENTIAL DAMAGES IRRESPECTIVE OF WHETHER TEKTRONIX OR THE VENDOR HAS ADVANCE NOTICE OF THE POSSIBILITY OF SUCH DAMAGES.

Table of Contents

Warranty	iii
List of Figures	viii
List of Tables	x
General Safety Summary	xi
Getting Started	1
Supplying Power	2
Connecting the TSG 95	3
Keypad and Display Conventions	4
Definitions	5
Preliminary Settings	5
Choose the Video Standard/Signal Set	5
Set the Battery Type	6
Enable (Disable) Auto Power Down	6
Other Settings	6
Operating Basics	7
Using Your TSG 95	7
Outputting Test Signals	9
Outputting Audio Tones	10
Selecting the Audio Frequency	10
Setting the Audio Tone Level (Amplitude)	11
Inserting Channel-ID Clicks in the Audio	11
Inserting ID Messages	11
Editing ID Messages	12
Positioning ID Messages	12
Saving ID Messages	13
Recalling ID Messages	14
Setting up an ID Cycle	14
Saving (Storing) Presets	15
Recalling Presets	16
Reference	17
The Utility Menu	17
Creating/Editing the User Signal Set	20
The Calibration Submenu	23

Appendix A: Characteristics	27
Safety Standard Compliance	27
EMI Compliance	27
Specification Tables	28
PAL Waveform Diagrams	43
NTSC Waveform Diagrams	56
NTSC JAPAN (No Setup) Waveform Diagrams	67
Appendix B: Replaceable Parts	69
Appendix C: User Service	71
Battery Hints	71
The BATTERY LOW Message	71
Low Battery Shutdown	71
Preventive Maintenance	72

List of Figures

Figure 1: PAL 75% Color Bars	43
Figure 2: PAL 100% Color Bars	43
Figure 3: PAL 75% Red and Red Field	44
Figure 4: PAL 100% Red	44
Figure 5: PAL Convergence (vertical lines)	45
Figure 6: PAL Convergence (horizontal lines)	45
Figure 7: PAL Pluge	46
Figure 8: PAL Green Field	46
Figure 9: PAL Safe Area	47
Figure 10: PAL Blue Field	48
Figure 11: PAL 100% Flat Field and Bounce (High)	48
Figure 12: PAL 50% Flat Field	49
Figure 13: PAL 0% Flat Field and Bounce (Low)	49
Figure 14: PAL Multiburst	49
Figure 15: PAL Reduced Sweep	50
Figure 16: PAL 5-Step (Gray Scale)	50
Figure 17: PAL Modulated 5-Step	51

Figure 18: PAL Matrix Signal — CCIR 17	51
Figure 19: PAL Matrix Signal — CCIR Line 330	52
Figure 20: PAL Matrix Signal — CCIR Line 331	52
Figure 21: PAL Matrix Signal — CCIR 18	53
Figure 22: PAL Matrix Signal — Sin(x)/x	53
Figure 23: PAL Matrix Signal — 15 kHz Square Wave	54
Figure 24: PAL Matrix Signal — Shallow Ramp	54
Figure 25: PAL Matrix Signal — UK ITS 1	55
Figure 26: PAL Matrix Signal — UK ITS 2	55
Figure 27: NTSC 75% Color Bars	56
Figure 28: NTSC Convergence Components	56
Figure 29: SMPTE (NTSC) Color Bar Components	57
Figure 30: NTSC Safe Area Signal Components	58
Figure 31: NTSC Red Field	60
Figure 32: NTSC 30 IRE and 50 IRE Flat Fields	60
Figure 33: NTSC 100 IRE Flat Field, Field Square Wave, and Bounce (High)	61
Figure 34: NTSC Black Burst	61
Figure 35: NTSC 5-Step Staircase (Gray Scale)	62
Figure 36: NTSC Multiburst	62
Figure 37: NTC7 (NTSC) Composite	63
Figure 38: NTC7 (NTSC) Combination	63
Figure 39: FCC (NTSC) Composite	64
Figure 40: NTSC Cable Multiburst	64
Figure 41: NTSC Cable Sweep	65
Figure 42: NTSC SIN(X)/X	65
Figure 43: NTSC Matrix	66
Figure 44: NTSC 0 IRE No Burst	66
Figure 45: NTSC Bounce (Low)	66
Figure 46: SMPTE (NTSC) Color Bars, No Setup	67
Figure 47: NTSC 75% Color Bars, No Setup	68
Figure 48: NTSC Red Field, No Setup	68
Figure 49: NTSC Black Burst, No Setup	68

List of Tables

Table 1: TSG 95 Video Test Signals	9
Table 2: General PAL Test Signal Characteristics	28
Table 3: Individual PAL Test Signal Characteristics	30
Table 4: PAL Vertical Interval Test Signals (VITS)	32
Table 5: General NTSC Test Signal Characteristics	33
Table 6: Individual NTSC Test Signal Characteristics	35
Table 7: NTSC JAPAN Test Signal Characteristics	39
Table 8: NTSC and NTSC JAPAN VITS	40
Table 9: Character Identification	40
Table 10: Audio Tone	40
Table 11: Power Supply	41
Table 12: Physical Characteristics	41
Table 13: Environmental Characteristics	42

General Safety Summary

Review the following safety precautions to avoid injury and prevent damage to this product or any products connected to it. To avoid potential hazards, use this product only as specified.

Only qualified personnel should perform service procedures.

To Avoid Fire or Personal Injury

Observe All Terminal Ratings. To avoid fire or shock hazard, observe all ratings and markings on the product. Consult the product manual for further ratings information before making connections to the product.

The common terminal is at ground potential. Do not connect the common terminal to elevated voltages.

Replace Batteries Properly. Replace batteries only with the proper type and rating specified.

Recharge Batteries Properly. Recharge batteries for the recommended charge cycle only.

Use Proper AC Adapter. Use only the AC adapter specified for this product.

Do Not Operate Without Covers. Do not operate this product with covers or panels removed.

Use Proper Fuse. Use only the fuse type and rating specified for this product.

Avoid Exposed Circuitry. Do not touch exposed connections and components when power is present.

Do Not Operate With Suspected Failures. If you suspect there is damage to this product, have it inspected by qualified service personnel.

Do Not Operate in Wet/Damp Conditions.

Do Not Operate in an Explosive Atmosphere.

Safety Terms and Symbols

Terms in This Manual. These terms may appear in this manual:



WARNING. Warning statements identify conditions or practices that could result in injury or loss of life.



CAUTION. Caution statements identify conditions or practices that could result in damage to this product or other property.

Terms on the Product. These terms may appear on the product:

DANGER indicates an injury hazard immediately accessible as you read the marking.

WARNING indicates an injury hazard not immediately accessible as you read the marking.

CAUTION indicates a hazard to property including the product.

Symbols on the Product. These symbols may appear on the product:



CAUTION
Refer to Manual



Double
Insulated

Battery Recycling

This product contains a Nickel Cadmium (NiCd) battery, which must be recycled or disposed of properly. For the location of a local battery recycler in the U.S. or Canada, please contact:

RBRC
Rechargeable Battery Recycling Corp.
P.O. Box 141870
Gainesville, Florida 32614

(800) BATTERY
(800) 227-7379
www.rbrc.com

Getting Started

Please read the following statements before using your new TSG 95 Pathfinder, then see the rest of the section for tips on supplying power, making preliminary settings, and connecting the instrument.



WARNING. *Install or replace batteries only with the instrument switched OFF and the AC adapter disconnected. Electrical shock or equipment damage can result.*



CAUTION. *Do not attempt to operate the TSG 95 with an improper AC adapter. Damage to the instrument can result.*

For best results, use the AC adapter supplied with the instrument. If the supplied adapter is incorrect for the local AC power supply, contact your nearest Tektronix representative.

The adapter voltage must be 9 to 15 VDC with an open-circuit voltage less than 18 VDC; the adapter connector must have the negative (–) polarity contact in the center.

NOTE. *Internal batteries are recommended when using an external power adapter. A loose adapter connector can cause the loss of some user settings and unexpected results the next time the instrument is powered on.*

The battery type, disposable or rechargeable, must be selected using through the Utility menu (see page 6). Failure to select the proper battery type can result in damage to the batteries and product.

Replace the batteries only with standard AA batteries (1.2–1.5 V, nominal), or the Tektronix rechargeable battery pack listed on page 69.

For more information, please contact your nearest Tektronix representative or field office. In the United States and Canada, you can also call the Tektronix information number, 1-800-TEK-WIDE (1-800-835-9433), between 8:00 am and 5:00 pm Pacific time.

Supplying Power

The TSG 95 is DC powered. You may power it with the standard AC adapter, the optional 9.6 V NiCad battery pack, eight standard AA batteries, or a “BP” type battery pack with the correct voltage and polarity. The external DC power connector is on the left side of the instrument.

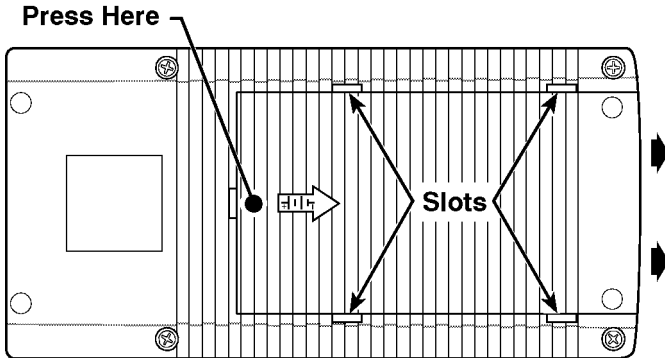

To install AA batteries or the battery pack, open the battery compartment of the TSG 95 by pressing down on the cover and sliding it in the direction of the inscribed arrow, as shown above. When the cover tabs line up with the slots in the case, lift the cover away from the instrument. Install batteries in alternating directions as indicated by the graphic molded into the “floor” of the battery compartment. If using the optional battery pack, take the time to identify both contacts and install the pack properly.

When selecting a power source for your TSG 95, please remember:

- Attempting to use an improper AC adapter can damage the instrument. See the Caution statement on the previous page.
- There is no need to remove the optional NiCad battery pack for recharging. The TSG 95 will “trickle charge” the battery pack whenever the standard AC adapter is used. Recharging the battery pack fully can take up to 16 hours. *Note that charging will occur only if the adapter supplies at least 12V; make sure that the adapter you use is appropriate for the local AC supply.*
- AA batteries are not included with the instrument; obtain them locally. Rechargeable AA batteries may be used, but they will NOT be recharged automatically by the AC adapter. To recharge

AA batteries, remove them from the instrument and use an appropriate battery charger. For safety, read and follow the battery charger instructions. Do NOT attempt to recharge standard alkaline batteries.

- After a minute with no key-press, the TSG 95 will automatically switch to lock out mode (as if you had pressed the Lock Out key); the display back light will shut off to conserve battery charge. When you want to resume keypad input, press **Lock Out** to exit lock out mode.
- To guard against battery discharge if you forget to turn the TSG 95 off after use, enable Auto Power Down through the Utility menu (see page 6).
- The TSG 95 can sense low battery voltage. It will warn you when the charge is sufficient for approximately ten more minutes of operation. The instrument will shut itself down when the battery voltage becomes too low for reliable operation. For proper function of these features, the Battery Type must be set correctly in the Utility menu.. Please see “Setting the Battery Type,” which follows.

The **ON** key toggles instrument power On and Off.

Connecting the TSG 95

Connect the Pathfinder to your equipment as you would any television test signal generator. Use 75 Ω coaxial cable (for video) and be sure that the signal path is properly terminated.

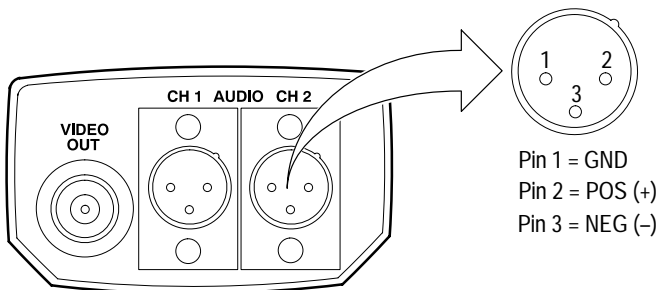

You may wish to confirm proper operation of your TSG 95—and gain familiarity with it—by first connecting it directly to a video or waveform monitor.

A performance verification procedure, which some users may require for acceptance testing, is included in the optional TSG 95 service manual (Tek p/n 070-8917-0x). To order a service manual, please contact your nearest Tektronix representative or field office.

Keypad and Display Conventions

Please see the Instruction card (p/n 070-8915-00) supplied with your TSG 95 for a “tour” of the keypad and an explanation of the display symbols. For your convenience, the following panels are taken from the card.

Display Symbols

 = Auto power-down enabled (symbol “rotates”). Disable through the Configuration menu: see the reverse side of this card for instructions.

 = Shift (Press **Shift** again to Shift Lock)

 = Shift Lock (Press **Shift** again to unlock)



 = Lockout enabled (Press **Lock Out** to unlock)

 = Blank ID Position; will not obscure test signal

Shift/Shift Lock

 Only the next key-press is shifted; shifted functions and characters are shown in yellow

Shift Lock

  All following keys are shifted (Until **Shift** is pressed again)

Keypad Lock Out

 Toggles keypad Lock/Unlock (when keypad is locked, only **Lock Out** and **On** keys are “active”)

Definitions

There are two phrases used in this manual that deserve a little explanation. We at Tektronix sincerely hope that these explanations do not confuse you further.

Signal Set— The group of signals that can be selected through the TSG 95 keypad at a given time. In the preprogrammed signal sets, all of the signals are the same video standard. You may create a “User” signal set, however, that contains both PAL and NTSC signals assigned to the letter keys of your choice, for easy selection.

Tone Level— One of four predefined audio output amplitudes that may be selected through the Tone menu. The levels (1 through 4) are “named” –10, 0, +4, and +8 dBu and calibrated to those amplitudes when the TSG 95 is manufactured. Qualified personnel, with the appropriate equipment, can rename and readjust the levels between –10 and +10 dBu. See page 24 for more discussion; see the Service manual for instructions.

Preliminary Settings

Once the Pathfinder is up and running, you should choose some settings depending on how you’ll be using the instrument. These settings are made through the Utility menu. Invoke the Utility menu by holding **Lock Out** down while pressing the **ON** key, then follow these directions to set the Video Standard and Battery Type, and enable Auto Power Down (if desired).

Choose the Video Standard/Signal Set

1. Use the ▲ and ▼ keys to scroll to the **SELECT STNDRD** menu item.
2. Select, with the ◀ and ▶ keys, the signal standard or “signal set” that is appropriate to your application. The choices are: **PAL**; **NTSC**; **NTSC JAPAN**, which includes NTSC signals with 0% setup; and **USER SIG SET**, the user-configurable signal set that can contain up to 26 signals of your choice—see page 20 for more information.
3. When the name of the desired signal set is displayed, continue to the **Battery Type**, or press any rectangular key to exit the Utility menu and return to normal operation.

Set the Battery Type

1. While still in the Utility menu, use the ▲ and ▼ keys to scroll to the BATTERY TYPE item.
2. Toggle to the selection that matches the type of battery you have installed in your TSG 95 by pressing either ◀ or ▶. The choices are “rechargeable” and “disposable.” Select rechargeable when using NiCad AA cells or the optional battery pack; choose disposable when you are using common Alkaline AA batteries, which cannot be recharged.
3. When the correct battery type is displayed, continue to Auto Power Down, or press any rectangular key to exit the Utility menu and return to normal operation.

Enable (Disable) Auto Power Down

“Auto Power Down” will switch the instrument off when ten minutes have passed without a key press. Enable this feature when you are using battery power and operating in an environment in which unplanned shutdown of the TSG 95 is permissible.

1. While still in the Utility menu, use the ▲ and ▼ keys to scroll to the AUTO PWR DOWN item.
2. Disable/enable Auto Power Down by pressing either ◀ or ▶. The new state will be in effect when you return to normal operation. Enabled Auto Power Down is indicated by a “rotating line” symbol in the upper-right corner of the Pathfinder display.
3. Use the ▲ and ▼ keys to access other Utility menu items, or press any rectangular key to exit the menu and resume normal operation.

Other Settings

There are other, less important TSG 95 settings that are configured through the Utility menu and its Calibration submenu. See “The Utility Menu,” beginning on page 17 for more information.

Operating Basics

To begin using the instrument as quickly as possible, see “Using your TSG 95,” below. For even more information on selected topics, turn to the Reference section of this manual, beginning on page 17.

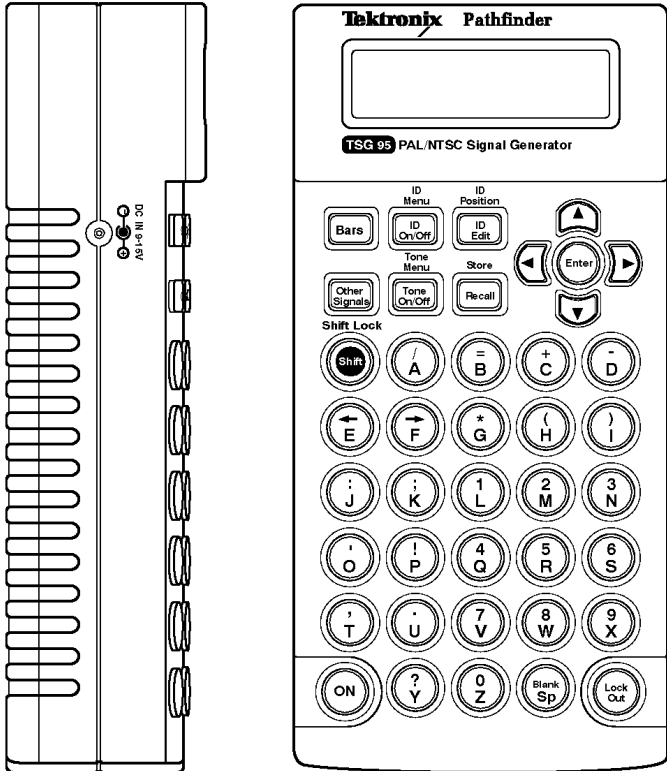

Using Your TSG 95

Here's what you can do with your TSG95. Instructions for each use begin on the indicated page.

- Output either PAL or NTSC video test signals (page 9). You can configure the instrument to generate:
 - PAL signals

- NTSC signals
- “NTSC JAPAN” signals that have 0 IRE (as opposed to 7.5 IRE, used in North America) setup
- A “User Signal Set” that can contain selections from all three lists, as well as VITS and non-VITS versions of the same signal (permitting you to choose VITS without entering the Utility menu). If you want, the User signal set can even include both PAL and NTSC signals.

See page 5 in the Getting Started section for information on choosing a video standard/signal set. Directions for creating (or editing) your own User signal set begin on page 20.

- Generate audio tones (page 10). You may:
 - Choose one of 13 discrete “factory” frequencies, or select a frequency sweep that sweeps repeatedly from 50 Hz to 20 kHz (page 10)
 - Designate three “User Frequencies” in the same range (page 23) and later output one of these frequencies
 - Select a factory-calibrated audio output level of -10, 0, +4, or +8 dBu (page 11)
 - Recalibrate the audio output to permit selection of any whole dB level between -10 and -3 dBu, or 0 through +10 dBu (*qualified service technicians only* — page 24)
 - Include channel-ID “clicks” in the audio output (page 11)
- Add an ID message to the video signal (pages 11), edit it (page 12), and place it in the vertical interval or position it where desired in the active video (page 12)
- Store up to eight ID messages for later use (page 13)
- Create a sequence of (up to four) stored ID messages that will cycle continuously in the output (page 14)
- Save all the current instrument settings as a “Preset” for later recall (page 15)

Outputting Test Signals

1. Connect the TSG 95 to your system and make the appropriate preliminary settings as described in the Getting Started section of this manual.
2. Switch the instrument on or return to normal operation by pressing either the Bars or Other Signals key. By default, the instrument “powers up” with the settings that were in effect when it was last switched off.
3. Select the desired test signal one of four ways:
 - Press the Bars key repeatedly to select among the available color bars signals. The signal will be output as soon as the name is displayed on the TSG 95 LCD.
 - Press the Other Signals key repeatedly to select among the “non-bars” signals. Again, the signal will be output as soon as its name is displayed on the LCD.
 - Use the ▲ and ▼ keys to scroll through the full list of signals until you get to the desired signal.
 - Press the appropriate letter key (A through U) to “direct-select” the signal. The available signals and their corresponding keys are listed in Table 1, below.

Table 1: TSG 95 Video Test Signals

PAL Signal Set	NTSC Signal Set	NTSC JAPAN Signal Set	Key
75% Bars	SMPTE Bars	SMPTE Bars*	A
100% Bars	75% Bars	75% Bars*	B
75% Bars/Red	Convergence	SNG Bars*	C
100% Bars/Red	Safe Area	Convergence	D
Convergence	Red Field	Safe Area	E
Pluge	50 IRE Flat Field	Red Field*	F
Safe Area	100 IRE Flat Field	50 IRE Flat Field	G
Green Field	Black Burst	100 IRE Flat Field	H
Blue Field	5-Step	Black Burst*	I
Red Field	Multiburst	5-Step	J

Table 1: TSG 95 Video Test Signals (Cont.)

PAL Signal Set	NTSC Signal Set	NTSC JAPAN Signal Set	Key
100% Flat Field	NTC7 Composite	Multiburst	K
50% Flat Field	NTC7 Combination	NTC7 Composite	L
0% Flat Field	FCC Composite	NTC7 Combination	M
Multiburst	Cable Multiburst	FCC Composite	N
60% Sweep	Cable Sweep	Cable Multiburst	O
5-Step	SIN X/X	Cable Sweep	P
Mod. 5-Step	Matrix	SIN X/X	Q
Matrix	0 IRE, no Burst	Matrix*	R
Field Square Wave	Field Square Wave	0 IRE, no Burst	S
Bounce	Bounce	Field Square Wave	T
—	—	Bounce	U

* These signals differ from those in the NTSC signal set.

Outputting Audio Tones

- Toggle the audio output On/Off by pressing the **Tone On/Off** key.

Selecting the Audio Frequency

1. Enter the Tone menu (press **Shift**, then **Tone On/Off**). The first menu item is TONE FREQ.
2. Use the ◀ and ▶ keys to select the desired frequency. The choices are:
 50, 63, 125, 250, and 400 Hz;
 1, 2, 4, 8, 10, 12.5, 16, and 20 kHz;
 USER1, USER2, USER3; and
 SWEEP 50–20K (a 50 Hz–20 kHz sweep)

You may specify the USER# frequencies through the Utility/Calibration menu; see page 23. (Note that there is no default value for USER3; therefore, the USER3 choice will not appear in a new—or reset—instrument.)

You can pause a sweep at any of its 27 frequency steps (listed in Table 10 in the Characteristics section) by pressing **Enter** when in the TONE FREQ menu item and SWEEP 50–20K is selected. The message SWEEP PAUSED will appear on the display. You may find this capability useful for checking a problem noticed at a particular frequency while sweeping. Press **Enter** a second time to resume the frequency sweep.

3. Tone frequencies are in effect as soon as they are indicated on the display. Scroll down to other Audio menu items with the **▼** key, or exit the menu by pressing any rectangular key.

Setting the Audio Tone Level (Amplitude)

1. In the Audio menu, use the **▼** or **▲** key to reach the TONE LEVEL item.
2. Use the **◀** and **▶** keys to select the desired level. When manufactured, the four TSG 95 tone levels are designated as –10, 0, +4, and +8 dBu and calibrated to those amplitudes. Qualified technicians may rename and recalibrate the tone levels to any integer value in the ranges of –10 to –3 dBu and 0 to +10 dBu. See page 24 for more information; see the optional Service manual for instructions.
3. The new tone level will be in effect immediately. Scroll to other Audio menu items with the **▼** or **▲** key, or exit the menu by pressing any rectangular key.

Inserting Channel-ID Clicks in the Audio

When click is enabled, the instrument will insert a single click into channel 1, and a double click into channel 2.

1. In the Audio menu, use the **▼** or **▲** key to reach the CLICK item.
2. Use the **◀** and **▶** keys to toggle the ID clicks On/Off.
3. Scroll to other Audio menu items with the **▼** or **▲** key, or exit the menu by pressing any rectangular key.

Inserting ID Messages

- Toggle the ID message or cycle on and off by pressing the **ID On/Off** key. The status of the ID—on, off, or cyc (cycle)—is

indicated on the second line of the TSG 95 display, as shown in the next illustration.

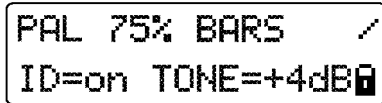

Editing ID Messages

In the TSG 95, only the current ID message may be edited. The “current” message is the ID that will appear in the output if ID=on. (The current ID will not appear in the output when ID=off, and may not appear in the output if ID=cyc, but it can still be edited and saved in either case.)

1. Press **ID Edit**. The current ID message will appear on the LCD.
2. Use the arrow keys to position the blinking underline cursor and enter text with the alphanumeric keys.
3. Press **Enter** or one of the rectangular keys to terminate the ID edit; the new ID will become the current ID. If ID=on, the new ID will be inserted into the video output. Note that if a stored ID or pre-set is recalled before new current ID is saved (see “Saving ID Messages,” page 13), the changes will be overwritten and lost.

Positioning ID Messages

The current ID can be positioned within the safe area of active video, or the first line can be placed in the vertical interval.

1. Press **Shift**, then **ID Edit**. The LCD will look something like this:

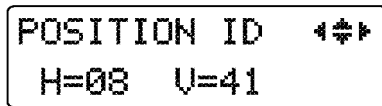

2. Change the horizontal (H) position with the ◀/▶ keys and the vertical (V) position with the ▲/▼ keys.

The H position can range from 00 (left edge of safe area) to 69-3n, where n is the number (1-16) of the right-most character position occupied by the message. Note that, when editing a short message (n<16) that has been placed as far to the right as pos-

sible, the end character positions will be occupied by ■ symbols. You will not be able to put characters in those positions until the message is repositioned to the left.

The V setting can range from 00 (top of safe area) to 41 (bottom). The vertical interval is indicated by V=vert; it is one ▲ key-press above V=00. Only the first ID message line will fit into the vertical interval.

3. When the ID message is in the desired position, press any rectangular key to resume normal operation. Note that the position of an ID message is part of its definition. You must save the ID message (see below) to save its new location. If a stored ID or preset is recalled before the current ID (in its new location) is saved, the new location will be lost.

Saving ID Messages

The contents and position of the current ID can be stored in one of eight ID# locations for later recall or inclusion in an ID cycle.

1. Press **Shift**, then **Recall**. The display will change to resemble this illustration:



```

STORE ID# 1◀▶
CURRENT MESSAGE▮

```

The first line of the current message will occupy the bottom half of the display. You may scroll between the first and second lines of the message with the ▼ and ▲ keys.

2. Use the ◀ and ▶ keys to select the ID# location (1 through 8) in which the current message is to be stored. Note that the previous contents of that location will be overwritten.
3. When the desired storage number is displayed, press **Enter** to save the message; press any rectangular key to abort the operation and return the instrument to normal operation.

Recall the message later with the **Recall** key, as described next.

Recalling ID Messages

1. Press the **Recall** key.
2. Use the ◀ and ▶ keys to select one of the ID message numbers, ID# 1 through ID# 8. The first line of the message will appear on the second display line; press the ▼ key to see the second line of the message. For example, if the saved ID# 1 is “TEKTRONIX TSG95 PAL/NTSC,” the display will first look like this:

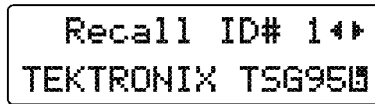

```
Recall ID# 1◀▶
TEKTRONIX TSG95
```

Pressing the ▼ key will change it to this:

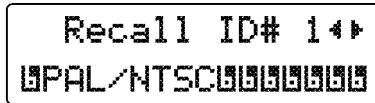

```
Recall ID# 1◀▶
PAL/NTSC
```

Note that an empty character position will show as a black space in the video, while the  symbol indicates a “Blank.” Underlying video will show through a Blank.

3. Press **Enter** to recall the ID message.
4. Press any rectangular key to exit the Recall menu and resume normal operation.

Setting up an ID Cycle

An ID cycle is a sequence of up to four stored ID messages. Once you set up a cycle, it will be inserted in the video output if: ID is toggled On with the **ID On/Off** key, and the ID CYCLE item of the ID menu is set to “on.” When those two conditions are met, the TSG 95 display will indicate ID=cyc during normal operation.

1. Edit and save the ID messages that you want to cycle (see “Editing ID messages,” page 12). Note the numbers of the IDs, and the order in which they should appear.
2. Enter the ID menu by pressing **Shift**, then **ID On/Off**.
3. Press ▼ twice to reach the **CYCLE SETUP** item, then press **Enter**. The display will resemble the following illustration.

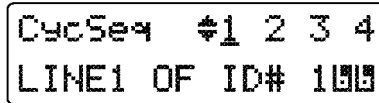

```

CycSeq #1 2 3 4
LINE1 OF ID# 100

```

4. Use the ◀/▶ keys to move the underline cursor to one of the four sequence “time intervals.” The IDs will appear in the order that their numbers appear—from left to right—on the display.
5. Use the ▲/▼ keys to select the number of the ID to appear during each interval. Choose the hyphen (it’s below #1) to eliminate the interval. If you want a blank interval (that is, a time gap between ID messages), you must create an all-blank ID to put in that interval.
6. When the correct ID numbers occupy all four time interval positions, press a rectangular key to exit the ID menu. The cycle sequence information will be written to the instrument’s memory.

Note that the TSG 95 “remembers” the ID#, not the actual message. Therefore, if you save a new message as ID# 1, the new message will appear the next time an ID cycle comes to a time interval in which ID# 1 is displayed.

7. To set the duration of each cycle time interval, re-enter the ID menu (by pressing **Shift**, then **ID On/Off**), then press the ▼ key to reach the CYCLE TIME menu item. Use the horizontal arrow keys to select the duration between one and nine seconds.
8. To insert the ID cycle instead of the current ID, scroll up the ID menu to the ID CYCLE (on/off) selection. Press ◀ or ▶ to toggle the selection. The cycle will appear in the picture if toggled on with the **ID On/Off** key.

Saving (Storing) Presets

1. Press **Shift** and then **Recall**.
2. Scroll through the “STORE ID” (#1 through #8) and “STO PRE-SET” (#1 through #4) locations with the ◀/▶ keys. The first line of the current ID will be displayed on the second line of the LCD.
3. When the desired storage number is displayed, press **Enter** to save the current instrument settings. Remember that storing the current

settings will overwrite the contents of the selected PRESET# location.

4. Press any rectangular key to exit the Store function.

A preset includes *most* of the instrument settings in effect when the preset is saved.. The settings not stored in a preset are: Standard/signal set; auto power down status; user tone frequencies; and battery type. While the current tone level (one of four possible; see page 5) becomes part of the preset, its name and actual amplitude—both set through the Calibration menu—are not.

Note also that while the *current* ID is saved, the particular messages used in a saved cycle are *not* stored. Thus, if the cycle stored with a preset “remembers” to display ID# 4 (for example), the *latest* message in ID# 4 will appear whenever that preset is recalled. Remember, editing an ID message can have an affect on what you get when you recall a preset.

Recalling Presets

1. Press **Recall**.
2. Scroll through the “RECALL ID” (#1 through #8) and “RCL PRESET” (#1 through #4) locations with the ◀/▶ keys. The first line of the preset’s “current” ID message will occupy the bottom line of the display; use the ▼ key to see the second line.
3. When the desired storage number is displayed, press **Enter** to recall the preset. The video and audio output of the TSG 95 will return to the signal and tone that was selected when the preset was stored.
4. Press any rectangular key to exit the Recall menu.

Reference

This section discusses several aspects of the TSG 95 that are manipulated or configured through the Utility menu. Important topics that are not discussed elsewhere in this manual include:

- Editing the User signal set, page 20
- Selecting User tone frequencies, page 23
- Audio Tone Level CAUTIONs, page 24
- Factory Reset, page 26

The Utility Menu

To enter the Utility menu, hold the Lock Out button down while pressing the ON button. To exit the Utility menu and resume normal operation, press any of the rectangular buttons at the top of the keypad, or scroll to the EXIT MENU item and press **Enter**.

The Utility menu items are listed below. Use the up (▲) and down (▼) arrow keys to scroll up and down the list. Note that there are two submenus: Calibration (CALIB) and Diagnostic (DIAGN). These submenus are discussed in separate sections, below.



1. Standard/Signal Set select; use the ◀ or ▶ key to select the desired set of signals. The choices are: PAL, NTSC, NTSC JAPAN (which includes NTSC signals with 0% Setup), and USER SIG SET.



2. This item permits construction or editing of a custom “User Signal Set” that can contain up to 26 signals chosen from a list of *all* the signals that the TSG 95 can generate. Thus you can create a User signal set that has both PAL and NTSC signals. Or you can

make a signal set that contains only the signals that you use regularly and “bind” them to letter keys that are easy for you to remember. For example, you can assign the Bounce signal to **B**, a Matrix without VITS to **M**, a Matrix with VITS to **N**, and the Red Field to **R**. (Note that control of VITS insertion through the next Utility menu item is disabled when the User signal set is active.)

Instructions for editing the Use signal set—with a list of all available signals—begin on page 20.



3. VITS (Vertical Interval Test Signals); use the ◀ or ▶ key to toggle between VITS SIGNALS and NO VITS SIGS. When VITS SIGNALS is selected, the listed signals will include VITS (see Tables 4 and 8 in the Characteristics section) whenever they are output.. This utility is disabled when the User signal set is selected.

Signals that can include VITS

- PAL 100% FLD
- PAL 50% FLD
- PAL 0% FIELD
- PAL MATRIX
- NTSC 100 IRE
- NTSC 50 IRE
- NTSC BLK BRST
- NTSC MATRIX
- JPN 100 IRE
- JPN 50 IRE
- JPN BLCK BRST
- JPN MATRIX

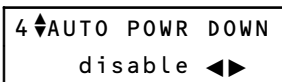

4. Auto power down; use the left (◀) or right (▶) arrow key to toggle between enabled and disabled.

The Auto Power Down function shuts the TSG 95 off to conserve battery charge when there has been no key press for approximately 10 minutes. The Auto Power Down symbol (a rotating line) appears in the upper-right corner of the display when the function is enabled.

5 ⬇ BATTERY TYPE disposable ◀▶

- Battery type; use the ◀ or ▶ key to toggle between disposable (Alkaline AA cells) or rechargeable (NiCad cells or the optional battery pack). For best results when operating the TSG 95 under battery power, this setting must match the installed type of battery.

6 ⬇ CALIB SUBMENU Press Enter

- Press **Enter** to “drop into” the Calibration submenu. This submenu includes items for specifying the User tone frequencies, choosing and calibrating audio tone amplitudes, and performing a “Factory Reset.” Please see the Calibration Submenu section, which begins immediately after this discussion of top level items.

7 ⬇ DIAGN SUBMENU Press Enter

- Press **Enter** to “drop into” the Diagnostic submenu. The Diagnostic submenu functions are intended for use when the instrument is manufactured or serviced. Please see the optional Service manual (Tektronix p/n 070-8917-0x) for more information.

⬇ EXIT MENU Press Enter

- To exit the Utility menu, scroll to this item and press **Enter**. The instrument will resume normal operation (notice that changes made through the Utility menu items and submenus will take effect immediately).

Creating/Editing the User Signal Set

1. When in the top level of the Utility menu, use the ▲ / ▼ keys to scroll the the SEL USER SIGS item.

```

2 ▾ SEL USER SIGS
    Press Enter
  
```

2. Press **Enter** to edit the User signal set. The display will become:

```

Key: A ◀▶ Enter
    ▾ NO SIGNAL
  
```

3. Select a letter key from A to Z with the ◀ and ▶ keys, or simply press the letter key itself.
4. Use the ▲ and ▼ keys to choose the signal (PAL, NTSC, or NTSC JAPAN) to be “associated” with the letter key. The available signals are listed in order below. Signals that include a VITS are indicated by an asterisk (*). The “No Signal” selections that separate the PAL, NTSC, and JPN portions of the list may be used to designate a letter key as “undefined.”

The specified signal will become part of the User signal set. You can select it (when the User signal set is active) with normal signal selection techniques: see the Operating Basics section of this manual or the TSG 95 Instruction card for details.

5. Add more signals to the User set by selecting additional letter keys (step 3) and choosing new signals for them (step 4). When you’re done, press **Enter** to exit the “SEL USER SIGS” item.

Signals available for the User Signal Set

```

PAL 75% BARS
PAL 100% BARS
PAL 75% / RED
PAL 100% / RED
PAL CONVERGENCE
PAL PLUGE
PAL SAFE AREA
PAL GREEN FIELD
  
```

Signals available for the User Signal Set (Cont.)

PAL BLUE FIELD
PAL RED FIELD
PAL 100% FIELD
PAL 100% FLD VT*
PAL 50% FIELD
PAL 50% FLD VT*
PAL 0% FIELD
PAL 0% FIELD VT*
PAL MULTIBURST
PAL 60% SWEEP
PAL 5-STEP
PAL MOD 5-STEP
PAL MATRIX
PAL MATRIX VTS*
PAL FLD SQ WAVE
PAL BOUNCE
NO SIGNAL
NTSC SMPTE BARS
NTSC 75% BARS
NTSC CONVERGENCE
NTSC SAFE AREA
NTSC RED FIELD
NTSC 100 IRE
NTSC 100 IRE VT*
NTSC 50 IRE
NTSC 50 IRE VT*
NTSC BLK BURST
NTSC BLK BRST V*
NTSC 5-STEP
NTSC MULTIBURST
NTSC NTC7 CMPST
NTSC NTC7 COMB.
NTSC FCC CMPST
NTSC CABLE MB

Signals available for the User Signal Set (Cont.)

NTSC CABLE SWP
NTSC SIN X/X
NTSC MATRIX
NTSC MATRIX VTS*
NTSC 0IREnoBRST
NTSC FLD SQ WAV
NTSC BOUNCE
NO SIGNAL
JPN SMPTE BARS
JPN 75% BARS
JPN SNG BARS
JPN CONVERGENCE
JPN SAFE AREA
JPN RED FIELD
JPN 100 IRE
JPN 100 IRE VTS*
JPN 50 IRE
JPN 50 IRE VTS*
JPN BLACK BRST
JPN BLCK BRST V*
JPN 5-STEP
JPN MULTIBURST
JPN NTC7 CMPST
JPN NTC7 COMB.
JPN FCC CMPST
JPN CABLE MB
JPN CABLE SWP
JPN SIN X/X
JPN MATRIX
JPN MATRIX VTS*
JPN 0IRE NoBRST
JPN FLD SQ WAVE
JPN BOUNCE

* Includes VITS (Vertical Interval Test Signal)

The Calibration Submenu

Only the “SET USR# TONE” items of this menu are intended for use by the typical TSG 95 user. Be sure you know what you are doing before using or changing any of the other submenu items.

1 \blacklozenge CALIBRATION
 UNLOCKED $\blacktriangleleft\blacktriangleright$

1. Toggle calibration from UNLOCKED to LOCKED with the \blacktriangleleft or \blacktriangleright key. When calibration is locked, only this and the EXIT SUBMENU menu items will be visible; when unlocked, all items in the calibration submenu will be available.

2 \blacklozenge SET USR1 TONE
 10395 Hz $\blacktriangleleft\blacktriangleright$

2. Set the “USER1” tone frequency with either the \blacktriangleleft and \blacktriangleright keys, or through direct input from the keypad. The keypad is automatically shifted when in this menu item, and only the number keys (0–9) are active. The selection range is 50 through 20000 Hz; the factory default is 10395 Hz.

3 \blacklozenge SET USR2 TONE
 7867 Hz $\blacktriangleleft\blacktriangleright$

3. Set the “USER2” tone frequency, again with either the \blacktriangleleft and \blacktriangleright keys, or through direct input from the keypad. Factory default is 7867 Hz.

4 \blacklozenge SET USR3 TONE
 - Hz $\blacktriangleleft\blacktriangleright$

4. Set the “USER3” tone frequency, again with either the \blacktriangleleft and \blacktriangleright keys, or through direct input from the keypad. Disable the User tone by pressing “-” (D). Factory default is no selection/disabled, as illustrated.

5 ◆ TONE MIN LEVL
ADJUST POT

5. Used during manufacture to set tone level DC offset. See the TSG 95 Service manual for more information.

6 ◆ NAME TONE LV1
-10dBu ◀▶

6. Name tone level 1: combined with the next menu item, this permits qualified users with the appropriate equipment to change tone level 1 from the factory default value of -10 dBu to a value of their choice. The possible selections are -10 to -3 dBu and 0 to +10 dBu. This item only changes the *name* of the level as it appears in the Tone menu.



CAUTION. Changing a tone level name (menu items 6, 8, A, and C) without recalibrating the amplitude through the following menu item is not recommended. Please see the Service manual (Tektronix p/n 070-8917-0x) for more information. A **FACTORY RESET** will **NOT** restore the tone level names to their original values.

7 ◆ CAL TONE LV1
-10dB: Low 17 ◀▶

7. Calibrate tone level 1: this item is used during manufacture to calibrate the first tone level to -10 dBu. Qualified users may also use it to readjust the tone amplitude to accurately reflect the level name chosen in the previous menu item. The range of adjustment is Low 00 to Hgh (high) 99.



CAUTION. Changing the “CAL TONE LV#” settings (menu items 7, 9, B, and D) will affect the audio tone amplitude and can give unexpected or inaccurate results. A **FACTORY RESET** will **NOT** restore these settings to their original values. These settings should be changed by **Qualified Service Personnel ONLY**. Please see the TSG 95 Service manual (p/n 070-8917-0x) for more information.

To ensure your ability to restore the original factory tone calibration settings in the case of inadvertent changes, please record the following information:

TSG 95 serial number: _____

Original -10 dB setting: _____ (e.g., Low 17)

Also take the time to record the settings for the remaining tone levels in menu (list) items 9, B (11), and D (13).

<p>8 \blacklozenge NAME TONE LV2 0dBu $\blacktriangleleft\blacktriangleright$</p>

8. Name tone level 2: use this—and the next menu item—to change tone level 2 from the factory default value of 0 dBu to a value of your choice. See menu/list item 6, above.

<p>9 \blacklozenge CAL TONE LV2 0dB: Hgh 00 $\blacktriangleleft\blacktriangleright$</p>

9. Calibrate tone level 2: please see menu/list item 7, above.
Original 0 dB setting: _____ (e.g., Low 99)

<p>A \blacklozenge NAME TONE LV3 +4dBu $\blacktriangleleft\blacktriangleright$</p>
--

10. Name tone level 3: use this—with the next menu item—to change tone level 3 from the factory default value of +4 dBu to a value of your choice. See menu/list item 6, above.

<p>B \blacklozenge CAL TONE LV3 +4dB: Hgh 25 $\blacktriangleleft\blacktriangleright$</p>
--

11. Calibrate tone level 3: please see menu/list item 7, above.
Original +4 dB setting: _____ (e.g., Hgh 25)

C ◆ NAME TONE LV4
+8dBu ◀▶

12. Name tone level 4: combined with the next menu item, this permits qualified users with the appropriate equipment to change tone level 4 from the factory default value of +8 dBu to a value of their choice. See menu/list item 6, above.

D ◆ CAL TONE LV4
+8dB: Hgh 65 ◀▶

13. Calibrate tone level 4: please see menu/list item 7, above.
Original +8 dB setting: _____ (e.g., Hgh 65)

E ◆ VIDEO CAL SIG
NORMAL SIG ◀▶

14. This item selects special output signals used during manufacture.

F ◆ FACTORY RESET

15. Press **Enter** to restore most of the original “as manufactured” instrument settings. **WARNING:** *All user selections, ID Messages, and Presets will be lost.* A factory reset may be appropriate when you wish to “erase” the User signal set, all ID messages, or all Presets. Factory Reset will *not* restore the original audio tone level names or calibration.

◆ EXIT SUBMENU
Press Enter

16. To exit the Calibration submenu, scroll to this item and press **Enter**. The instrument will return to the “CALIB SUBMENU” item in the Utility menu. To exit the entire Utility menu from this point, and resume normal instrument operation, press any rectangular key.

Appendix A: Characteristics

The information in this section is included for the convenience of the TSG 95 operator. It is not intended as a complete list of guaranteed specifications. The waveform illustrations represent properly decoded output. For a full list of instrument specifications, as well as performance verification and adjustment procedures, please see the TSG 95 Service Manual (Tektronix p/n 070-8917-0X).

***NOTE.** Shielded cables were used in the EMI certification of this instrument; therefore, it is recommended that shielded cables be used when operating. (EC 92)*

Safety Standard Compliance

The following safety standards apply to the TSG 95:

- ANSI S82 — Safety Standard for Electrical and Electronic Test, Measuring, Controlling, and Related Equipment, 1988.
- CAN/CSA C22.2 No. 231 M89 — CSA Safety Requirements for Electrical and Electronic Measuring and Test Equipment.
- IEC1010-1 — Safety Requirements for Electrical Equipment for Measurement, Control, and Laboratory Use (1990).
- UL1244 — Standard for Electrical and Electronic Measuring and Testing Equipment, Second Edition (1980).

EMI Compliance

The following electromagnetic interference (EMI) standard applies to the TSG 95:

- 47 CFR, Chapter 1 (FCC Rules), Part 15, Class A.

Refer to the compliance statement at the front of this manual for other standards.

Specification Tables

Table 2: General PAL Test Signal Characteristics

Characteristic	Performance Requirements	Supplemental Information
Luminance Amplitude Accuracy	$\pm 1\%$ of 700 mV	
Chrominance-to-Luminance Gain	$\pm 2\%$ of 700 mV	1% typical.
Blanking Level	0 V \pm 50 mV	
Rise Time Accuracy	$\pm 10\%$	Except where otherwise specified
Burst Amplitude	300 mV \pm 2% of 700 mV	
Sync Amplitude	300 mV \pm 2% of 700 mV	
Sync Rise Time	250 ns	
Output Impedance		75 Ω
Return Loss		≥ 36 dB at 4.2 MHz
Subcarrier Stability	4.43361875 MHz \pm 10 Hz	Over a temperature range of 0 to +40° C. Annual adjustment required.
Signal-to-Noise Ratio		≥ 60 dB; Signal passed through a continuous random noise measurement low pass filter, $F_c=5$ MHz.
Chrominance-to-luminance Delay	≤ 10 ns	≤ 5 ns typical.
SCH Phase	$0^\circ \pm 5^\circ$	
Frequency Response to 4.8 MHz to 5.8 MHz	Flat within $\pm 2\%$ Flat within $\pm 3\%$	$\sin(X)/X \pm 1$ dB to 5 MHz
Field Tilt	$\leq 0.5\%$	
Line Tilt	$\leq 0.5\%$	
5-Step Linearity Error	$\leq 1\%$	Relative step matching.
Differential Gain	$\leq 1\%$	Averaged, $\leq 5\%$ typical
Differential Phase	$\leq 1^\circ$	Averaged
2T Pulse K-Factor	$\leq 0.5\%$	Ringing $\leq 1.5\%$ peak.

Table 2: General PAL Test Signal Characteristics (Cont.)

Characteristic	Performance Requirements	Supplemental Information
Luminance Rise Time	Digitally derived	250 ns \pm 50 ns Except where otherwise specified
Chrominance Rise Time	Digitally derived	350 ns \pm 50 ns Except where otherwise specified
Burst Rise Time	Digitally derived	350 ns \pm 50 ns; greater than BBC specifications to prevent ringing.
Line Timing	Digitally derived	All signals comply with PAL timing specifications; see Figures 1 through 26.
Front Porch Duration	Digitally derived	1.55 μ s minimum
Line Blanking Interval	Digitally derived	12.0 μ s \pm 0.15 μ s, measured at the 50% point of active video.
Breezeway Duration	Digitally derived	900 ns \pm 50 ns
Line Sync Duration	Digitally derived	4.7 μ s \pm 50 ns at half-amplitude
Vertical Serration Duration	Digitally derived	4.7 μ s \pm 50 ns at half-amplitude
Equalizing Pulse Duration	Digitally derived	2.35 μ s \pm 50 ns at half-amplitude
Burst Delay from Sync Duration	Digitally derived	5.6 μ s \pm 50 ns from half-amplitude point of Sync 2.25 μ s \pm 0.1 μ s (10 cycles of subcarrier)

Table 3: Individual PAL Test Signal Characteristics

Characteristic	Information		
<i>75% Bars</i> Luminance Rise Times	See Figure 1 150 ns		
Packet Characteristics:	Luminance Amplitude (mV)	Subcarrier Amplitude (mV _{p-p})	Subcarrier Phase (degrees)
White	700.0	0.0	0.0
Yellow	465.1	470.5	167.1
Cyan	368.0	663.8	283.5
Green	308.2	620.1	240.7
Magenta	216.8	620.1	60.7
Red	157.0	663.8	103.5
Blue	59.9	470.5	347.1
<i>100% Bars</i> Luminance Rise Times	See Figure 2 150 ns		
Packet Characteristics:	Luminance Amplitude (mV)	Subcarrier Amplitude (mV _{p-p})	Subcarrier Phase (degrees)
White	700.0	0.0	0.0
Yellow	620.2	627.3	167.1
Cyan	490.7	885.1	283.5
Green	410.9	826.8	240.7
Magenta	289.1	826.8	60.7
Red	209.3	885.1	103.5
Blue	79.8	627.3	347.1
<i>75% Bars over Red</i> Luminance Rise Times Field Timing Color Bars Red	See Figures 1 and 3 150 ns Lines 24–166 & 336–478 Lines 167–310 & 479–622		
Packet Characteristics	See 75% Bars, above.		
<i>100% Bars over Red</i> Luminance Rise Times Field Timing Color Bars Red	See Figures 2 and 4 150 ns Lines 24–166 & 336–478 Lines 167–310 & 479–622		
Bars Packet Chars.	See 100% Bars, above.		
Red Luminance Pedestal	209.3 mV		
Red Chrominance Ampl.	885.1 mV _{p-p}		
Red Chrominance Phase	103.5°		

Table 3: Individual PAL Test Signal Characteristics (Cont.)

Characteristic	Information
<i>Convergence</i> Amplitude Pattern Pulse HAD	See Figures 5 and 6 525.0 mV 19 vertical lines and 14 horizontal lines per field 225 ns
<i>Pluge</i> Pluge Levels Lum Ref Levels	See Figure 7 -14 mV and +14 mV 700 mV, 450 mV, 200 mV, and 110 mV
<i>Safe Area</i> Amplitude	See Figure 9 525 mV
<i>Green Field</i> Luminance Pedestal Chrominance Amplitude Chrominance Phase	See Figure 8 308.2 mV 620.1 mV _{p-p} 240.7°
<i>Blue Field</i> Luminance Pedestal Chrominance Amplitude Chrominance Phase	See Figure 10 59.9 mV 470.5 mV _{p-p} 347.1°
<i>Red Field</i> Luminance Pedestal Chrominance Amplitude Chrominance Phase	See Figure 4 157.0 mV 663.8 mV _{p-p} 103.5°
<i>Flat Field</i> 100% 50% 0%	700 mV (see Figure 11) 350 mV (see Figure 12) 0 mV (see Figure 13)
<i>Multiburst</i> White Bar Amplitude Packet Amplitudes Pedestal Burst Frequencies Packet Rise Time	See Figure 14 420 mV _{p-p} 420 mV _{p-p} (Equal width packets) 350 mV 0.5, 1.0, 2.0, 4.0, 4.8, and 5.8 MHz 350 ns typical
<i>60% Reduced Line Sweep</i> Frequency Amplitude Markers	See Figure 15 500 Hz to 6.5 MHz 420 mV _{p-p} 1, 2, 3, 4, 5, and 6 MHz
<i>5-Step (Grey Scale)</i> Amplitude	See Figure 16 700 mV

Table 3: Individual PAL Test Signal Characteristics (Cont.)

Characteristic	Information
<i>Modulated 5 Step</i>	See Figure 17
Luminance Amplitude	700, 560, 420, 280, and 140 mV
Chrominance Amplitude	280.0 mV _{p-p}
Chrominance Phase	60.7°
<i>Matrix (Signal)</i>	(Lines)
CCIR 17	24–47 & 336–359 See Figure 18
CCIR 330	48–71 & 360–383 See Figure 19
CCIR 331	72–95 & 384–407 See Figure 20
CCIR 18	96–119 & 408–431 See Figure 21
75% Color Bars	120–143 & 432–455 See Figure 1
Sin(X)/X	144–166 & 456–478 See Figure 22
75% Red Field	167–190 & 479–502 See Figure 3
15 kHz Square Wave	191–214 & 503–526 See Figure 23
50% Flat Field	215–238 & 527–550 See Figure 12
Shallow Ramp	239–262 & 551–574 See Figure 24
UK ITS 1	263–286 & 575–598 See Figure 25
UK ITS 2	287–310 & 599–622 See Figure 26
<i>Field Square Wave</i>	See Figures 11 and 13
Field Timing	
Lines (White)	Lines 89–244 (and 401–556)
Lines at Blanking	All remaining active lines
Amplitude	700 mV
<i>Bounce</i>	See Figures 11 and 13
Amplitude	0 or 700 mV flat field
Rate	≈ 1.0 second high, ≈ 1.0 second low

Table 4: PAL Vertical Interval Test Signals (VITS)

Waveform	Line(s)
CCIR 17	17
CCIR 18	18
ITS 1	19 and 332
ITS 2	20 and 333
CCIR 330	330
CCIR 331	331

Table 5: General NTSC Test Signal Characteristics

Characteristic	Performance Requirements	Supplemental Information
Luminance Amplitude Accuracy	$\pm 1\%$ of 714.3 mV (100 \pm 1 IRE)	
Chrominance-to-Luminance Gain	$\pm 2\%$ of 714.3 mV (100 \pm 2 IRE)	1% typical.
Blanking Level	0 V \pm 50 mV	
Rise Time Accuracy	$\pm 10\%$	Except where otherwise specified
Burst Amplitude	285.7 mV (40 IRE) $\pm 2\%$ of 100 IRE	
Sync Amplitude	285.7 mV (40 IRE) $\pm 2\%$ of 100 IRE	
Sync Rise Time	140 ns \pm 20 ns	
Output Impedance		75 Ω
Return Loss		≥ 36 dB at 4.2 MHz
Subcarrier Stability	3.579545 MHz \pm 10 Hz	Over a temperature range of 0 to +40° C. Annual adjustment required.
Signal-to-Noise Ratio		≥ 60 dB; Signal passed through a continuous random noise measurement low pass filter, $F_c=5$ MHz.
Chrominance-to-Luminance Delay	≤ 15 ns	10 ns typical. Measured with the NTC7 Composite signal.
SCH Phase	0° \pm 5°	
Frequency Response	Flat within $\pm 2\%$ to 4.2 MHz	Sin(X)/X ± 1 dB to 4.2 MHz
Field Tilt	$\leq 0.5\%$	
Line Tilt	$\leq 0.5\%$	
5-Step Linearity Error	$\leq 1\%$	Relative step matching.
Differential Gain	$\leq 1\%$	Averaged
Differential Phase	$\leq 1^\circ$	Averaged
2T Pulse K-Factor	$\leq 0.5\%$	Ringing $\leq 1.5\%$ peak.
Luminance Rise Time	Digitally derived	250 ns

Table 5: General NTSC Test Signal Characteristics (Cont.)

Characteristic	Performance Requirements	Supplemental Information
Chrominance Rise Time	Digitally derived	400 ns
Burst Rise Time	Digitally derived	400 ns
Line Timing	Digitally derived	See Figures 27 through 49
Front Porch Duration	Digitally derived	$1.5 \mu\text{s} \pm 0.1 \mu\text{s}$
Line Blanking Interval	Digitally derived	$10.9 \mu\text{s} \pm 0.2 \mu\text{s}$, measured at the 20 IRE point of active video.
Breezeway Duration	Digitally derived	$600 \text{ ns} \pm 100 \text{ ns}$
Line Sync Duration	Digitally derived	$4.7 \mu\text{s} \pm 100 \text{ ns}$ Half-amplitude duration (HAD)
Vertical Serration Duration	Digitally derived	$4.7 \mu\text{s} \pm 100 \text{ ns}$ (HAD)
Equalizing Pulse Duration	Digitally derived	$2.3 \mu\text{s} \pm 100 \text{ ns}$ (HAD)
Burst Delay from Sync Duration	Digitally derived	$5.308 \mu\text{s} \pm 35 \text{ ns}$ (19 cycles of subcarrier) $2.51 \mu\text{s} \pm 0.1 \mu\text{s}$ (9 cycles of subcarrier)

Table 6: Individual NTSC Test Signal Characteristics

Characteristic	Information		
<i>SMPTE Bars</i>	See Figure 29		
Rise Times			
Luminance	140 ns		
Chrominance			
-I	250 ns		
Q	833 ns		
Field Timing			
Color Bars	Lines 21-182	See Figure 29a	
Reverse Blue Bars	Lines 183-202	See Figure 29b	
IYQB	Lines 203-262	See Figure 29c	
Packet Characteristics:	Luminance Amplitude (Pedestal, mV)	Subcarrier Amplitude (p-p, mV)	Subcarrier Phase (degrees)
White	549.1	00.0	00.0
Yellow	492.6	443.3	167.1
Cyan	400.9	626.6	283.5
Green	344.5	585.2	240.7
Magenta	258.2	585.2	60.7
Red	201.7	626.6	103.5
Blue	110.1	443.3	347.1
-I	53.6	285.7	303.0
Q	53.6	285.7	33.0
<i>75% Color Bars</i>	See Figure 27 Full Field Color Bars, 75% Amplitude, 7.5% Setup, 100 IRE White Flag.		
<i>Convergence</i>	See Figure 28		
Amplitude	549.3 mV (76.9 IRE)		
Pattern	Crosshatch: 14 horizontal/17 vertical lines per field		
Pulse HAD	225 ns		
<i>Safe Area</i>	See Figure 30		
Amplitude	549.1 mV (76.9 IRE)		
Safe Title			
Horizontal Bar	Lines 45 and 238		
Vertical Timing	14.925 and 56.525 μ s		
Safe Action			
Horizontal Bar	Lines 33 and 250		
Vertical Timing	12.325 and 59.125 μ s		

Table 6: Individual NTSC Test Signal Characteristics (Cont.)

Characteristic	Information
<i>Red Field</i> Luminance Pedestal Chrominance Amplitude Chrominance Phase	See Figure 31 201.74 mV (28.3 IRE) 626.66 mV _{p-p} (87.8 IRE) 103.5°
<i>50 IRE Flat Field</i> Amplitude	See Figure 32 357.2 mV
<i>100 IRE Flat Field</i> Amplitude	See Figure 33 714.3 mV
<i>Black Burst</i> Amplitude	See Figure 34 53.57 mV (7.5 IRE)
<i>(SIN X)X</i> Spectrum	See Figure 42 -3 dB at 4.75 MHz
<i>5-Step Staircase</i> Amplitude	See Figure 35 714.3 mV (100 IRE)
<i>Multiburst</i> Amplitudes White Reference Bar Packets Pedestal Burst Frequencies Packet Rise Time 0.5 MHz All Other Packets	See Figure 36 500 mV (70 IRE) 428.6 mV _{p-p} (60 IRE), equal width packets 285.7 mV (40 IRE) 0.5, 1.0, 2.0, 3.0, 3.58, and 4.2 MHz 140 ns typical (sine-squared packets) 400 ns typical (sine-squared packets)
<i>NTC7 Composite</i> Bar Amplitude Rise Time 2T Pulse Amplitude HAD Modulated Sin ² Pulse Phase Amplitude HAD Modulate 5-Step Staircase Luminance Chrominance	See Figure 37 714.3 mV (100 IRE) 125 ns 714.3 mV (100 IRE) 250 ns 60.8° ± 1° 714.3 mV (100 IRE) at peak amplitude 1.563 μs 642.9 mV (90 IRE) 285.7 mV (40 IRE)

Table 6: Individual NTSC Test Signal Characteristics (Cont.)

Characteristic	Information
<i>NTC7 Combination</i>	See Figure 38
Multiburst	
Amplitudes	
White Bar	714.3 mV (100 IRE)
Packets	357.2 mV (50 IRE)
Pedestal	357.2 mV (50 IRE)
Burst Frequencies	0.5, 1.0, 2.0, 3.0, 3.58, and 4.2 MHz
Packet Rise Times	
0.5 and 1.0 MHz	140 ns typical (sine-squared packets)
All Other Packets	400 ns typical (sine-squared packets)
Modulated Pedestal	
Pedestal Amplitude	357.2 mV (50 IRE)
Chrominance Ampl.	142.9 mV (20 IRE), 285.7 mV (40 IRE), and 571.4 mV (80 IRE)
Phase	90°
Rise Time	400 ns
<i>FCC Composite</i>	See Figure 39
Bar	
Amplitude	714.3 mV (100 IRE)
Rise Time	250 ns
2T Pulse	
Amplitude	714.3 mV (100 IRE)
HAD	250 ns
Modulated Sin ² Pulse	
Phase	60.8° ± 1°
Amplitude	714.3 mV (100 IRE)
HAD	1.563 μs
Modulate 5-Step Staircase	
Luminance	571.4 mV (80 IRE)
Chrominance	285.7 mV (40 IRE)
Rise Time	375 ns
<i>Cable Multiburst</i>	See Figure 40
Amplitudes	
White Ref. Bar	428.6 mV (60 IRE)
Packets	428.6 mV _{p-p} (60 IRE), equal width packets
Pedestal	214.3 mV (30 IRE)
Burst Frequencies	0.5, 1.25, 2.0, 3.0, 3.75, and 4.0 MHz
Packet Rise Time	
0.5 MHz	140 ns typical (sine-squared packets)
All Other Packets	400 ns typical (sine-squared packets)

Table 6: Individual NTSC Test Signal Characteristics (Cont.)

Characteristic	Information
<i>Cable Sweep</i>	See Figure 41
Frequency	100 Hz to 4.2 MHz, lines 21–202
Amplitude	714.28 mV _{p-p} (100 IRE)
Markers	.5, 1, 2, 3, 3.75, and 4 MHz, lines 203–263
<i>Matrix</i>	Field Lines (inclusive; see Figure 43)
NTC7 Composite	21–69
NTC7 Combination	70–117
Color Bars	118–165
Sin(X)/X	166–213
50 IRE Flat Field	214–262
<i>0 IRE No Burst</i>	See Figure 44 0 mV
<i>Field Square Wave</i>	See Figure 33
Field Timing	
Lines (White)	Lines 70-213
Lines at Blanking	All remaining active lines
Amplitude	714.3 mV (100 IRE)
<i>Bounce</i>	See Figures 45 and 33
Amplitude	0 or 100 IRE flat field
Rate	≈ 1.0 second high, ≈ 1.0 second low

Table 7: NTSC JAPAN Test Signal Characteristics

Characteristic	Information
<i>SMPTE Bars, No Setup</i>	See Figure 46
Rise Times	
Luminance	140 ns
Chrominance	
-I	250 ns
Q	833 ns
Field Timing	
Color Bars	Lines 21-182 See Figure 46a
Reverse Blue Bars	Lines 183-202 See Figure 46b
IYQB	Lines 203-262 See Figure 46c
Packet Characteristics:	Luminance Subcarrier Subcarrier Amplitude Amplitude Phase (Pedestal, mV) (p-p, mV) (degrees)
White	535.1 00.0 00.0
Yellow	476.8 479.3 167.1
Cyan	375.0 677.5 283.5
Green	316.1 632.6 240.7
Magenta	219.6 632.6 60.7
Red	160.7 677.5 103.5
Blue	58.9 479.3 347.1
-I	0.0 285.7 303.0
Q	0.0 285.7 33.0
<i>75% Color Bars, No Setup</i>	See Figure 47 Full Field Color Bars; 75% Amplitude, No Setup with a 100 IRE White Flag.
<i>SNG Bars (Matrix)</i>	Field Lines (inclusive):
30 IRE Flat Field	21-162 and 209-262 See Figure 32
SMPTE Bars, 0 Setup	163-197 See Figure 46a
IYQB	198-208 See Figure 46c
<i>Red Field, No Setup</i>	See Figure 48
Luminance Pedestal	160.14 mV (22.4 IRE)
Chrominance Ampl.	677.08 mV _{p-p} (94.8 IRE)
Chrominance Phase	103.5
<i>Black Burst, No Setup</i>	See Figure 49 0 mV (0 IRE)

Table 8: NTSC and NTSC JAPAN VITS

Waveform	Line(s)
NTC7 Composite	17
NTC7 Combination	280

Table 9: Character Identification

Characteristic	Information
Number of Characters Displayed	Two lines of up to 16 characters per line
Display Position	Movable within the Safe Action area of the picture. One line (the first) may be in the Vertical Blanking Interval.
Character Amplitude, PAL Character Amplitude, NTSC	Black: 105 mV; White: 630 mV Black: 85.7 mV (12 IRE); White: 585.7 mV (82 IRE)

Table 10: Audio Tone

Characteristic	Information
Amplitude	Factory calibrated: -10, 0, +4, or +8 dBu into 600 Ω ; may be readjusted by user (<i>qualified personnel only</i>)
Amplitude Accuracy	± 0.25 dBu, as adjusted during manufacture
Connector Polarity	Pin 1 = GND; Pin 2 = POS (+); Pin 3 = NEG (-)
Output Impedance	50 Ω
Frequency	50, 63, 125, 250, and 400 Hz; 1, 2, 4, 8, 10, 12.5, 16, and 20 kHz; Sweep, and three user selections
Frequency Accuracy	± 0.5 Hz
Sweep	1 kHz for 5 s followed by 0.5 s at each of the following frequencies: 50, 63, 80, 100, 125, 160, 200, 250, 315, 400, 500, 630, and 800 Hz; then 1, 1.25, 1.6, 2, 2.5, 3.15, 4, 5, 6.3, 8, 10, 12.4, 16, and 20 kHz.
Distortion (THD)	$\leq 1\%$ (20 kHz bandwidth)
Audio ID "click" (click ON)	Channel 1, 1 click Channel 2, 2 clicks Channel clicks are offset for positive channel identification.

Table 11: Power Supply

Characteristic	Information
Altitude Operating Storage	to 15,000 feet (4572 m); IEC 1010-1 compliance to 2000 m to 50,000 feet (15420 m)
DC Input Range	9 to 15 VDC
Fuse	2 A, 32 V min
Power Limit without adapter with adapter	3.25 W 5.25 W
Power Consumption Audio and Back light off Audio and Back light on	Typical (not charging): 2.0 W 2.5 W
Peak Inrush Current	1.95 A @230 VAC, Environment E2

Table 12: Physical Characteristics

Characteristic	Performance Information
Height	5.6 cm (2.2 in)
Width	9.1 cm (3.6 in)
Depth	19.1 cm (7.5 in)
Net Weight TSG 95 TSG with battery pack	0.48 kg (1.06 lb) 0.68 kg (1.5 lb)
Shipping Weight	1.50 kg (3.31 lb) with AC adapter

Table 13: Environmental Characteristics

Characteristic	Information
Temperature Operating	0° C to +50° C (32 to +122° F); IEC 1010-1 compliance to +40° C
Storage	-30° C to +65° C (-22 to +149° F)
Altitude Operating	to 15,000 feet (4572 m); IEC 1010-1 compliance to 2000 m
Storage	to 50,000 feet (15420 m)
Equipment Type	Test
Equipment Class	Class III (as defined in IEC 1010-1, Annex H)
Installation Category	Category II (as defined in IEC 1010-1, Annex J) Note: Rated for indoor use only.
Pollution Degree	Pollution Degree 2 (as defined in IEC 1010-1)
Transportation	Meets the requirements of NTSB Test Procedure 1A, category II (24 inch drop)

PAL Waveform Diagrams

NOTE. Time references in the following waveform diagrams apply to the signal's half-amplitude points or pulse peaks, unless indicated otherwise.

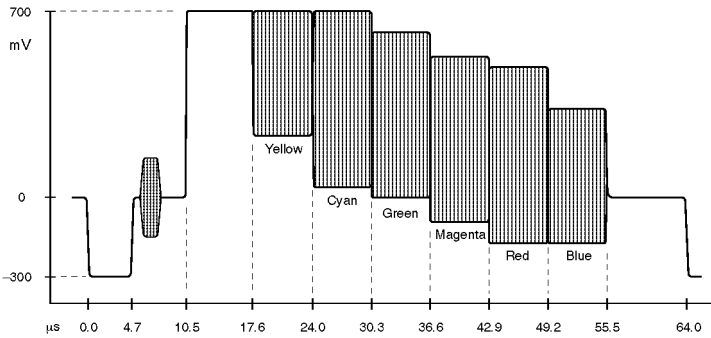

Figure 1: PAL 75% Color Bars

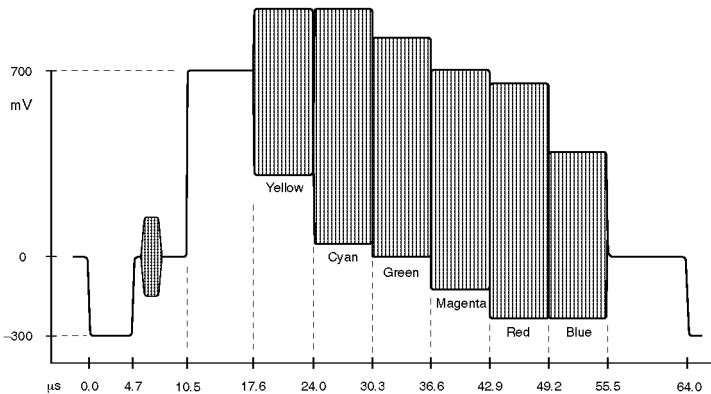

Figure 2: PAL 100% Color Bars

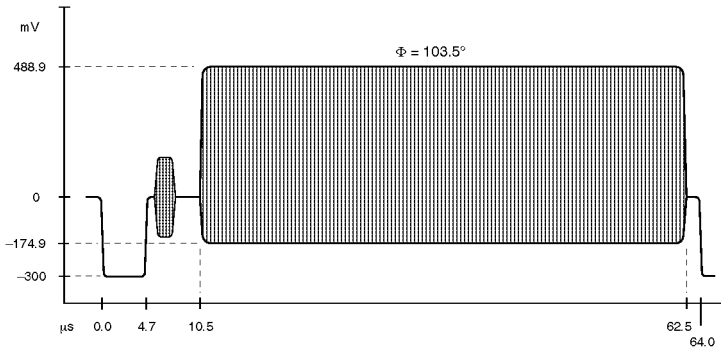

Figure 3: PAL 75% Red and Red Field

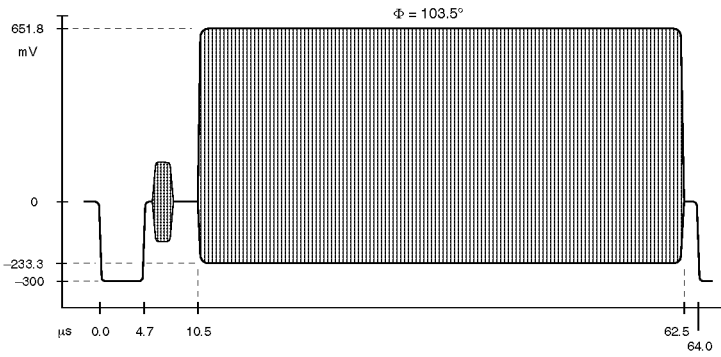

Figure 4: PAL 100% Red

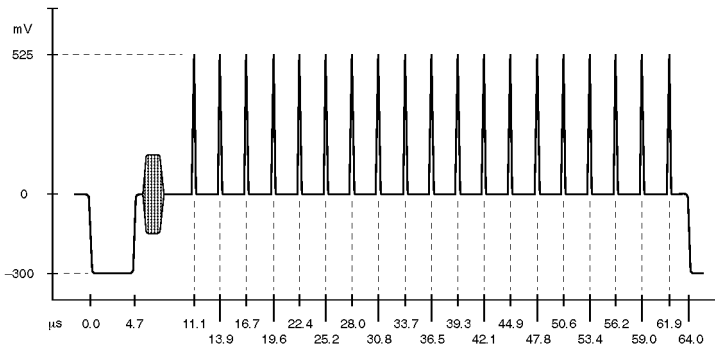

Figure 5: PAL Convergence (vertical lines)

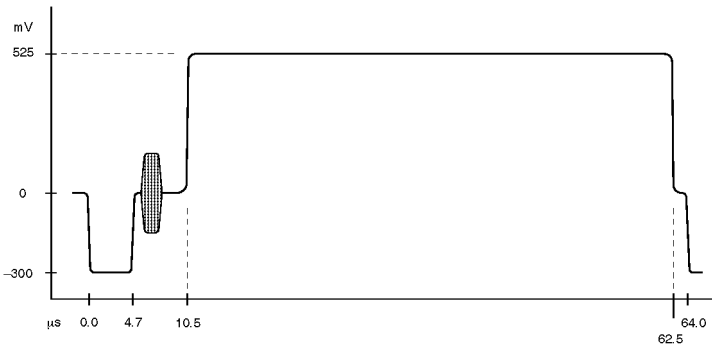

Figure 6: PAL Convergence (horizontal lines)

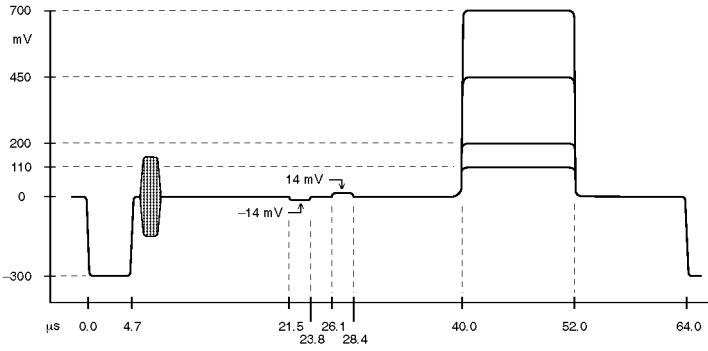

Figure 7: PAL Pluge

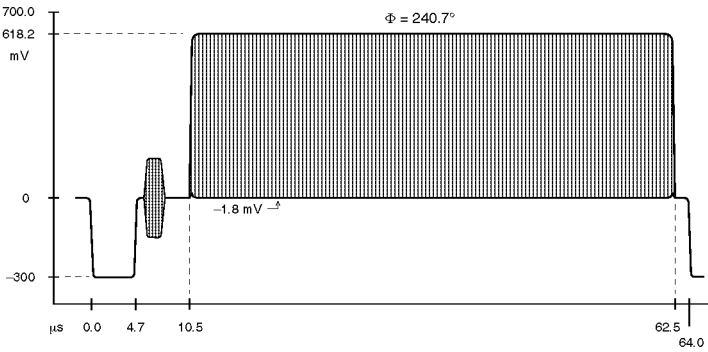
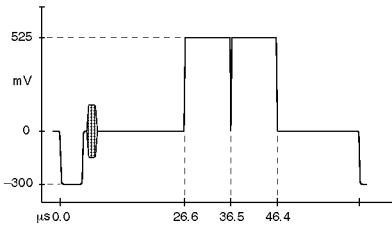
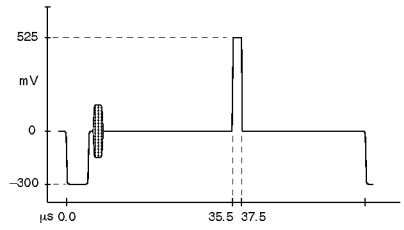

Figure 8: PAL Green Field



Lines 52 and 282



Line 167

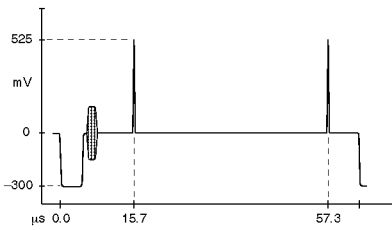

Lines 113-159 and 175-221

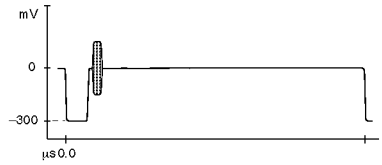

All remaining lines

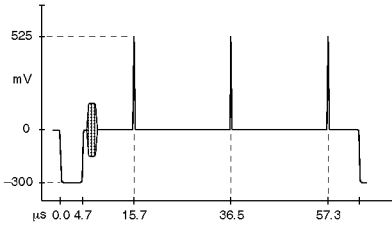

Lines 160-166 and 168-174

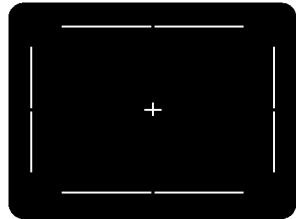

Safe Area display

Figure 9: PAL Safe Area

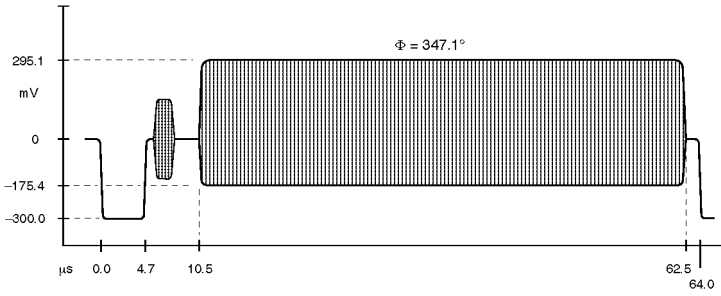

Figure 10: PAL Blue Field

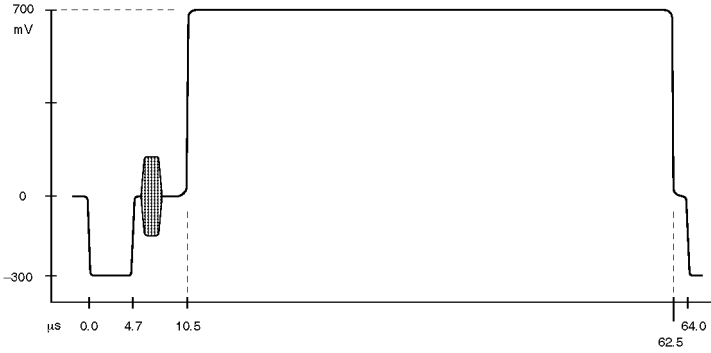

Figure 11: PAL 100% Flat Field and Bounce (High)

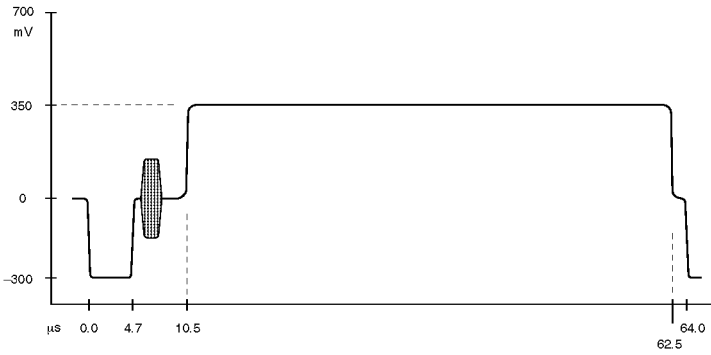

Figure 12: PAL 50% Flat Field



Figure 13: PAL 0% Flat Field and Bounce (Low)

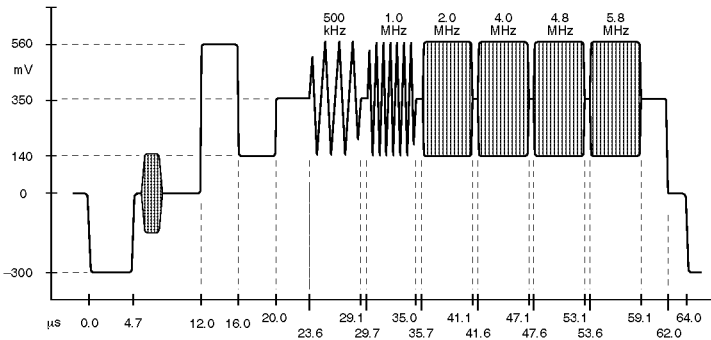

Figure 14: PAL Multiburst

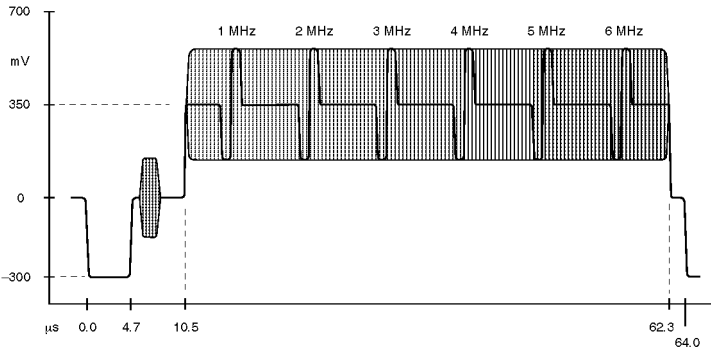

Figure 15: PAL Reduced Sweep

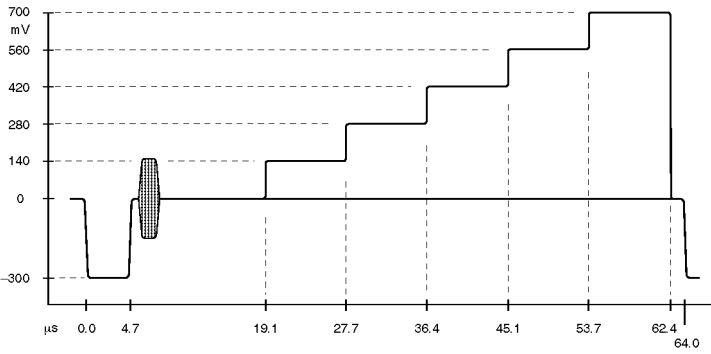

Figure 16: PAL 5-Step (Gray Scale)

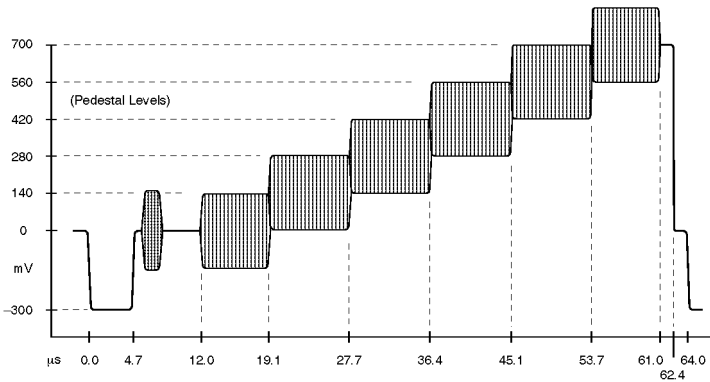

Figure 17: PAL Modulated 5-Step

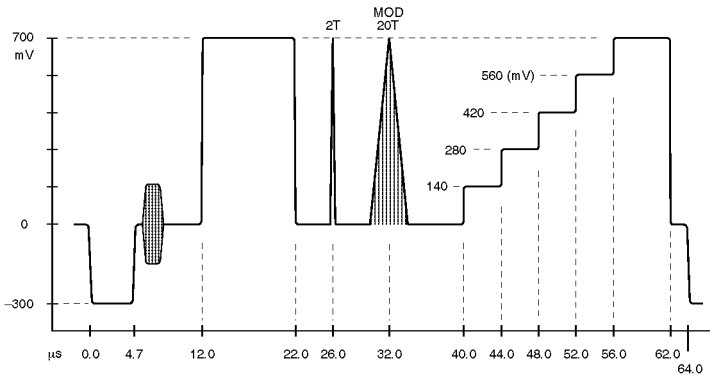

Figure 18: PAL Matrix Signal — CCIR 17

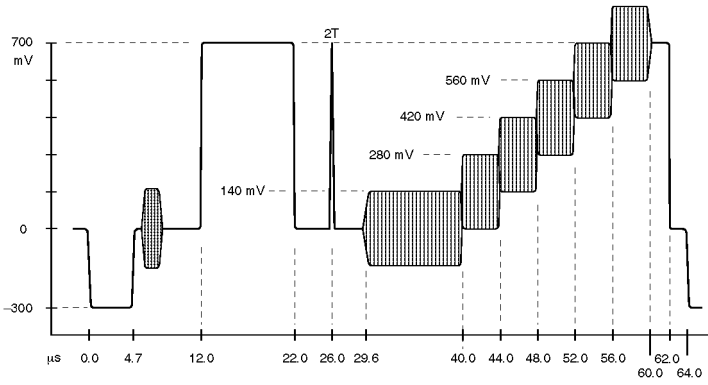

Figure 19: PAL Matrix Signal — CCIR Line 330

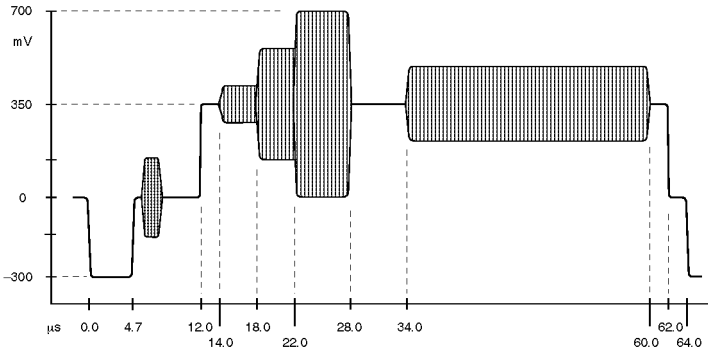

Figure 20: PAL Matrix Signal — CCIR Line 331

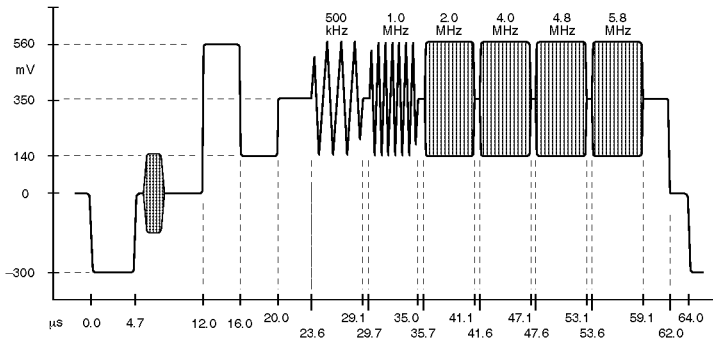

Figure 21: PAL Matrix Signal — CCIR 18

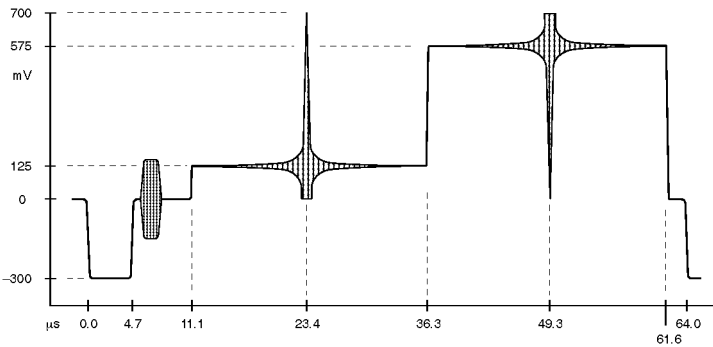

Figure 22: PAL Matrix Signal — $\text{Sin}(x)/x$

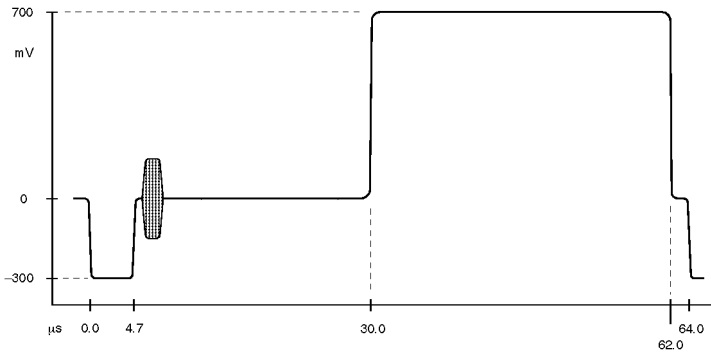

Figure 23: PAL Matrix Signal — 15 kHz Square Wave

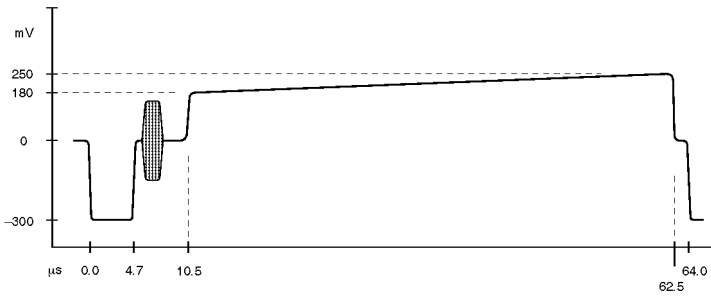

Figure 24: PAL Matrix Signal — Shallow Ramp

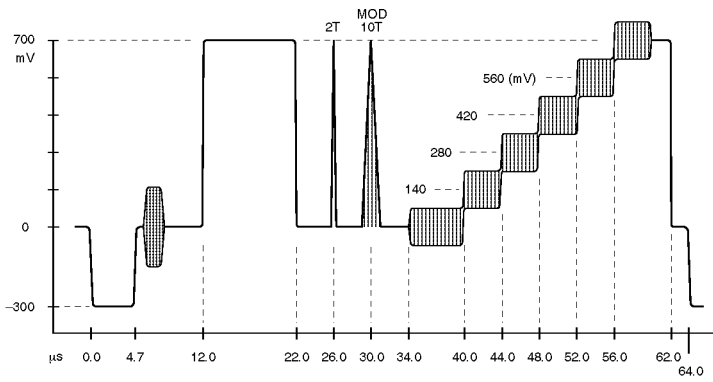

Figure 25: PAL Matrix Signal — UK ITS 1

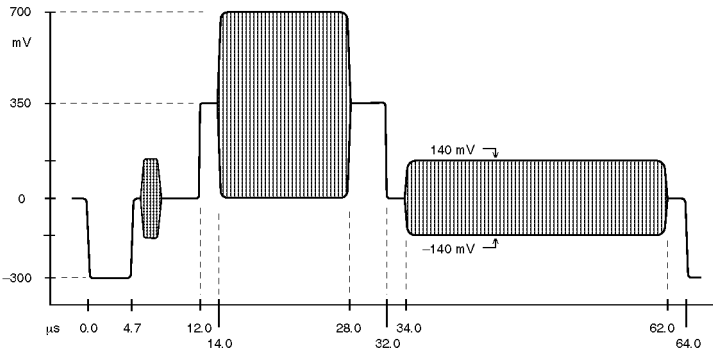

Figure 26: PAL Matrix Signal — UK ITS 2

NTSC Waveform Diagrams

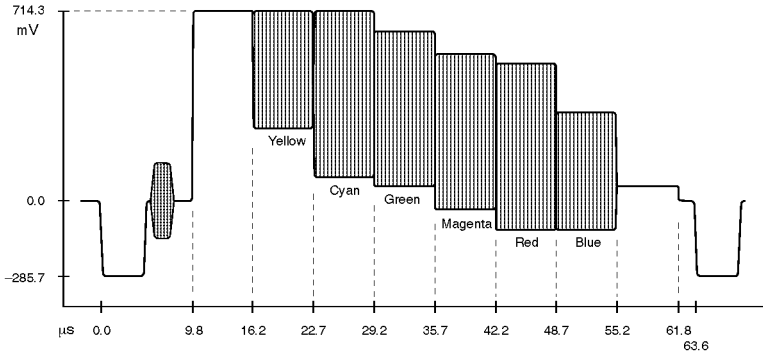

Figure 27: NTSC 75% Color Bars

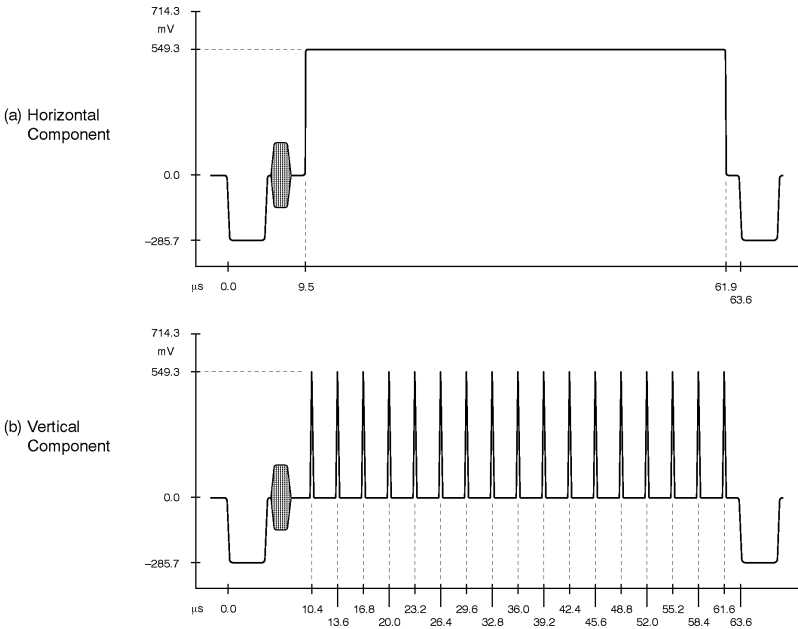
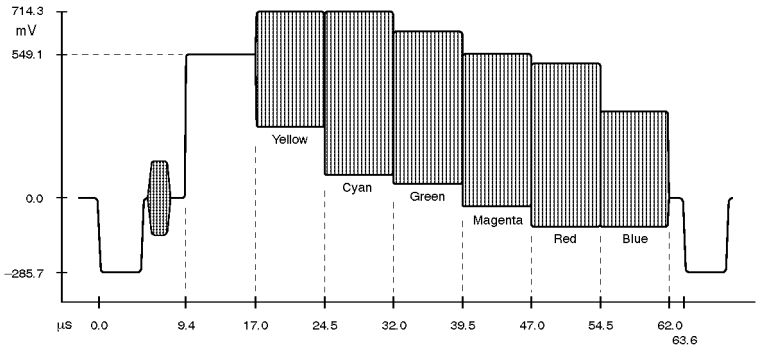
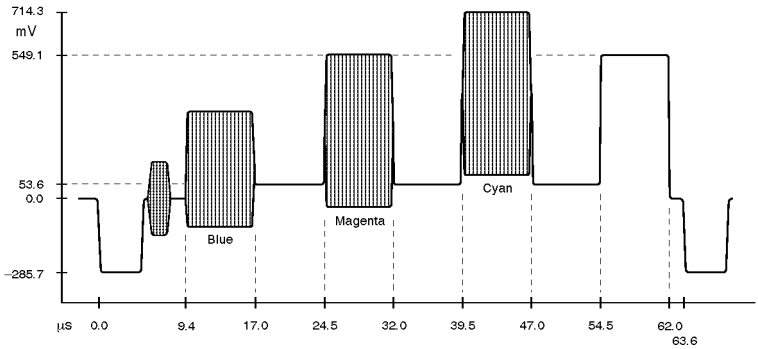

Figure 28: NTSC Convergence Components



(a) Color Bars (EIA Color Bars), lines 21-182



(b) Reverse Blue Bars, lines 183-202

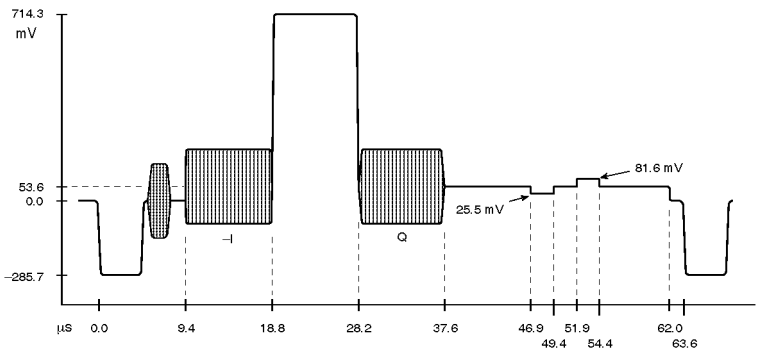

(c) IQB for SMPTE Bars, lines 203-262

Figure 29: SMPTE (NTSC) Color Bar Components

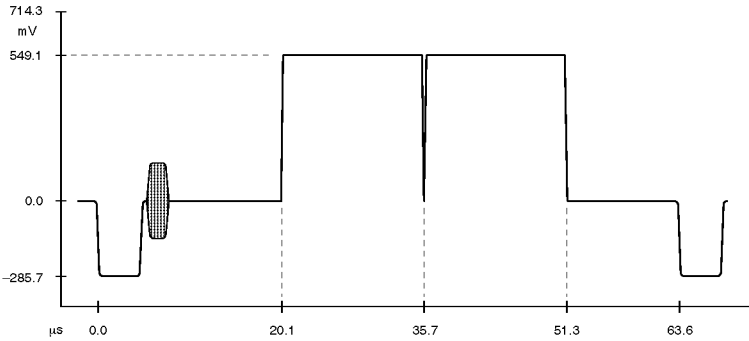

Lines 33, 45, 238, and 250

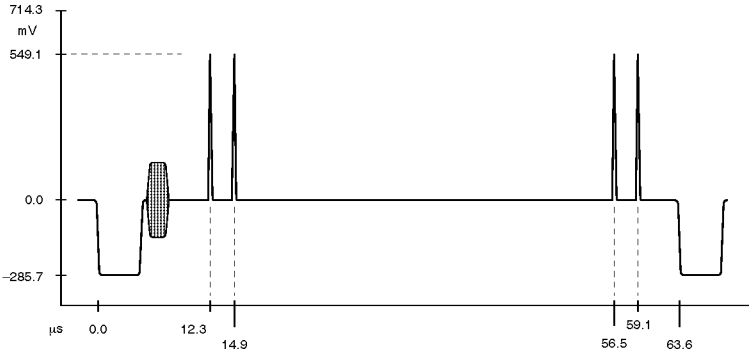

Lines 69-132 and 149-213

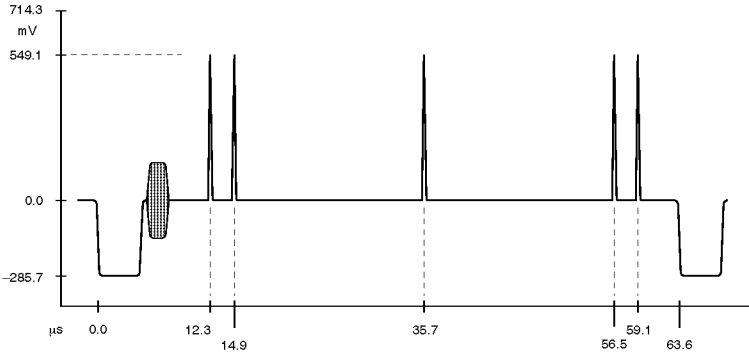

Lines 133-140 and 142-148

Figure 30: NTSC Safe Area Signal Components

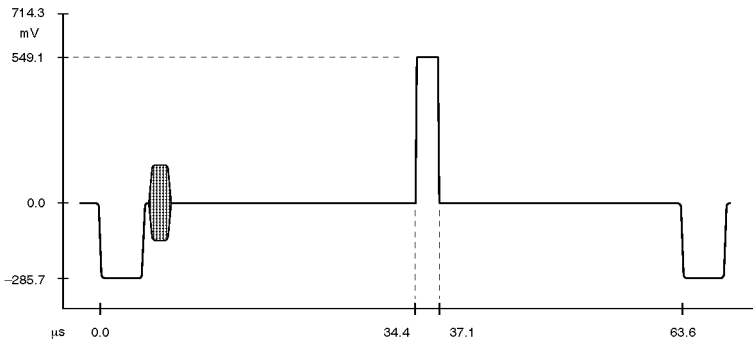

Line 141

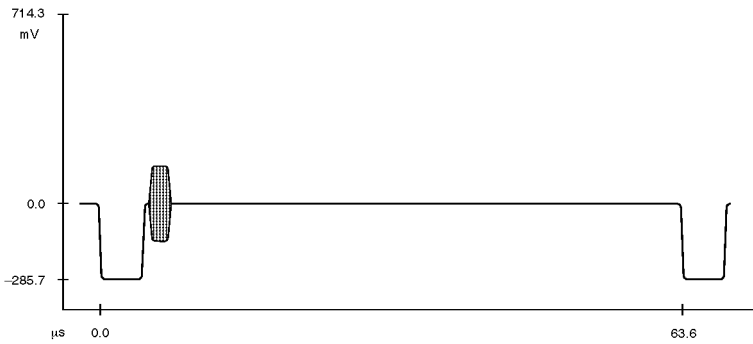

All remaining lines

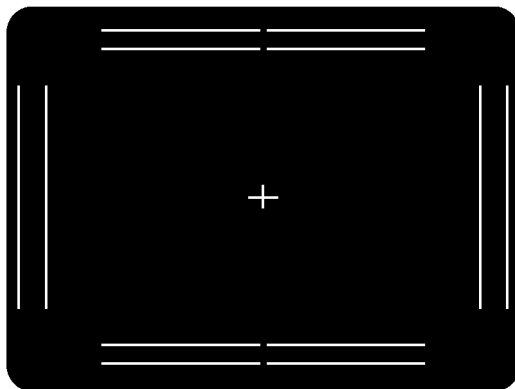

Safe Area display

Figure 30 (cont.): NTSC Safe Area Signal Components

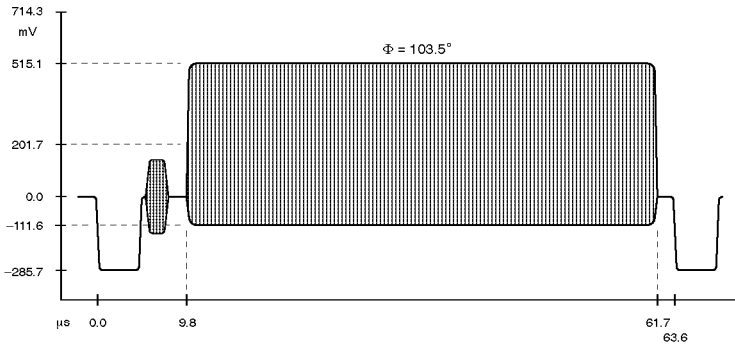

Figure 31: NTSC Red Field

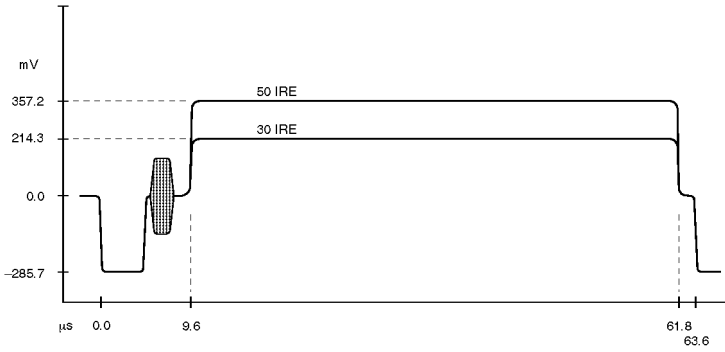

Figure 32: NTSC 30 IRE and 50 IRE Flat Fields

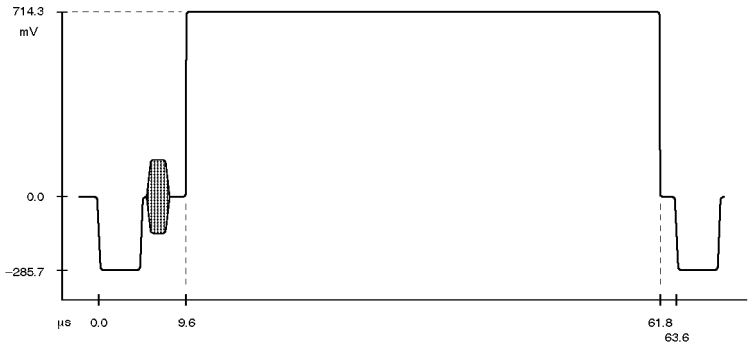

Figure 33: NTSC 100 IRE Flat Field, Field Square Wave, and Bounce (High)

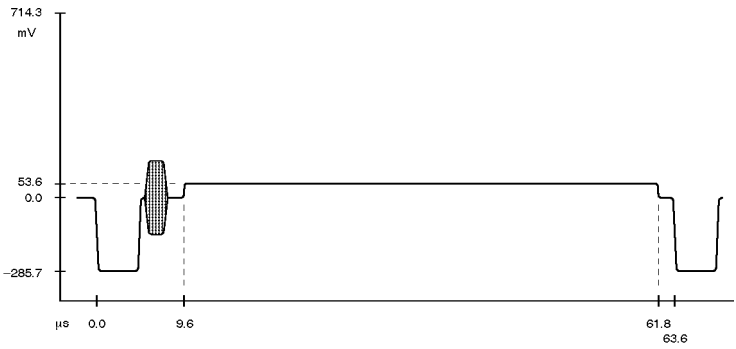

Figure 34: NTSC Black Burst

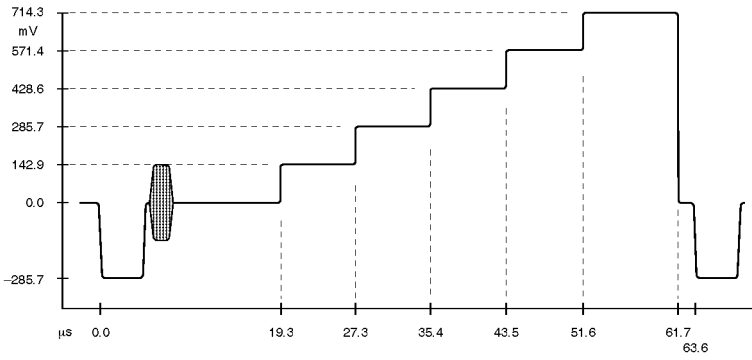

Figure 35: NTSC 5-Step Staircase (Gray Scale)

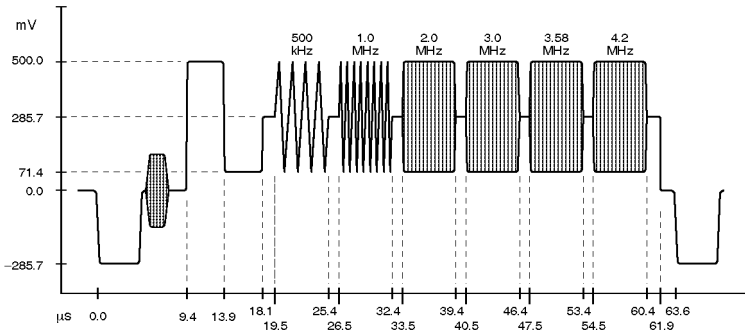

Figure 36: NTSC Multiburst

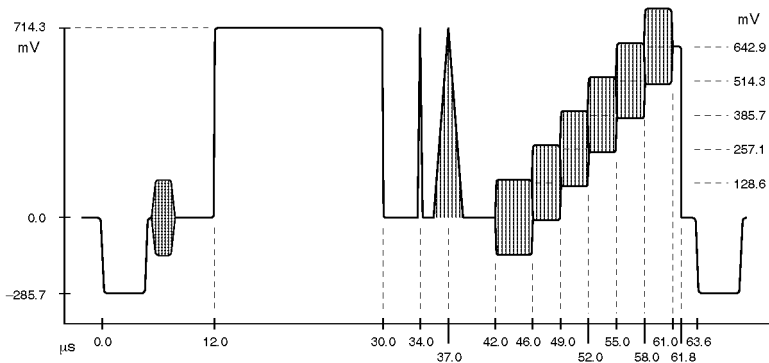

Figure 37: NTC7 (NTSC) Composite

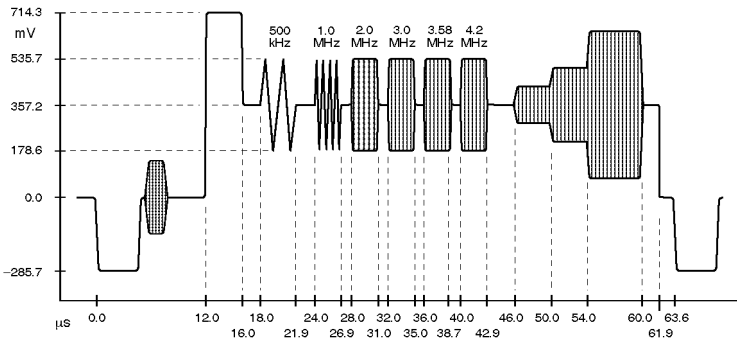

Figure 38: NTC7 (NTSC) Combination

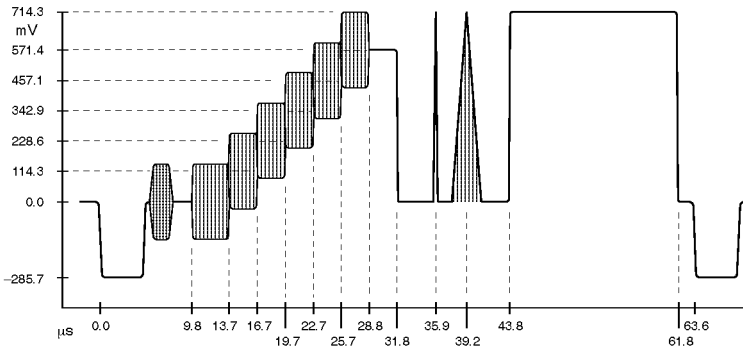

Figure 39: FCC (NTSC) Composite

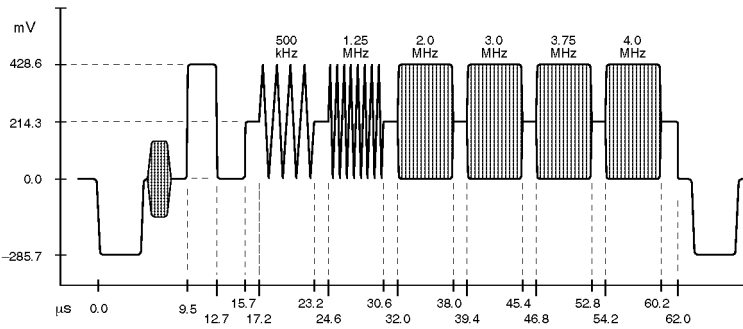

Figure 40: NTSC Cable Multiburst

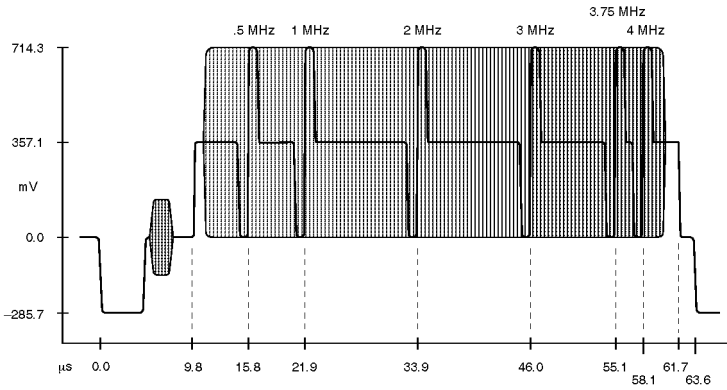

Figure 41: NTSC Cable Sweep

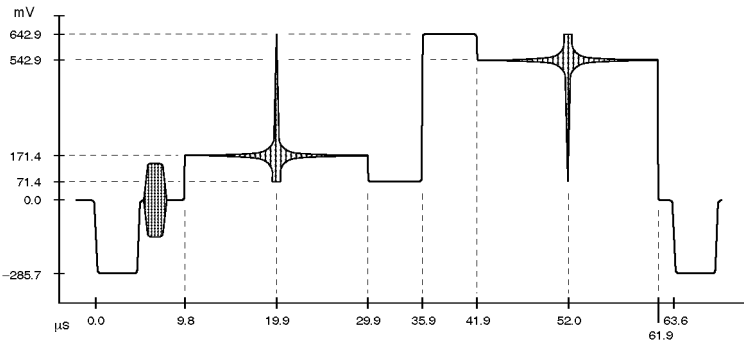

Figure 42: NTSC SIN(X)/X

Lines:

21	NTC7 Composite
69	
70	NTC7 Combination
117	
118	Color Bars
165	
166	SIN(x) _x
213	
214	50 IRE Flat Field
262	

Figure 43: NTSC Matrix

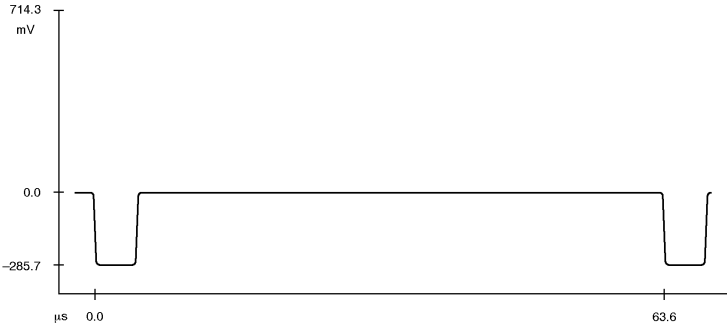

Figure 44: NTSC 0 IRE No Burst

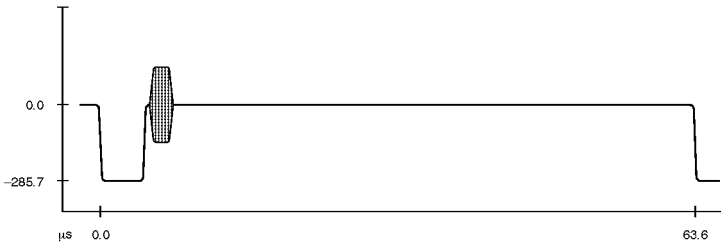

Figure 45: NTSC Bounce (Low)

NTSC JAPAN (No Setup) Waveform Diagrams

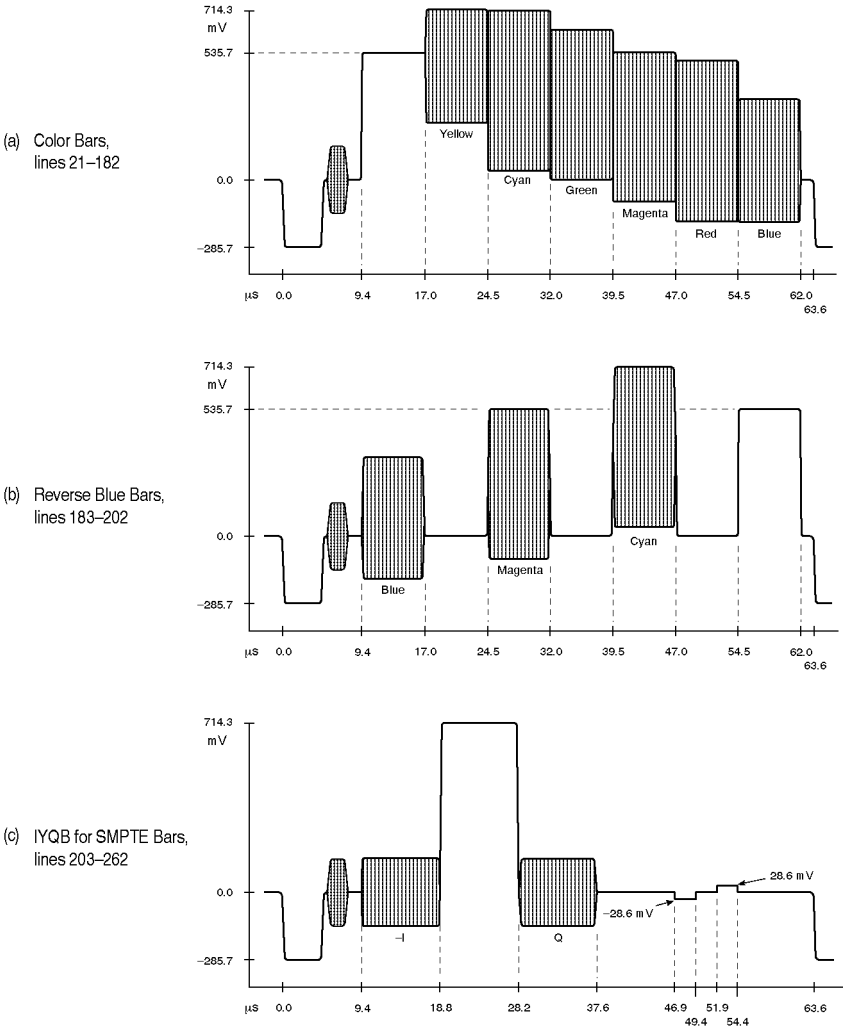

Figure 46: SMPTE (NTSC) Color Bars, No Setup

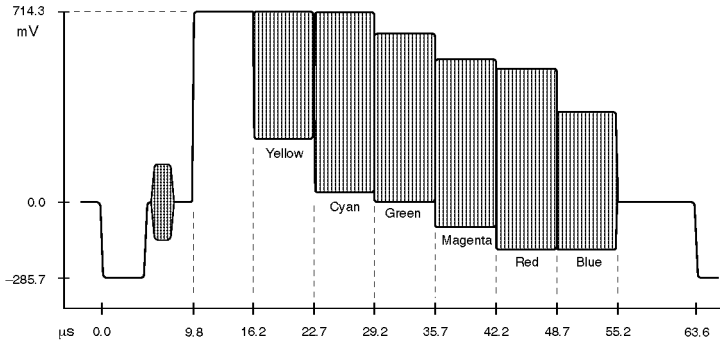

Figure 47: NTSC 75% Color Bars, No Setup

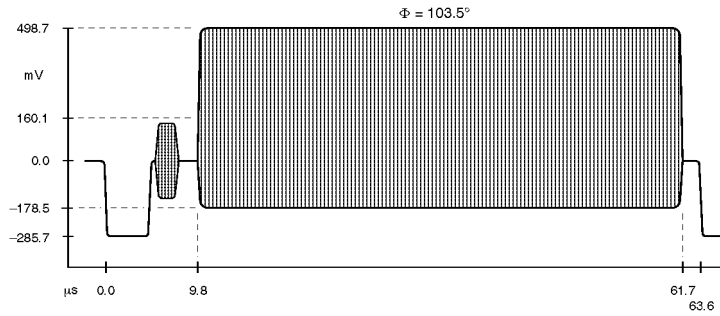

Figure 48: NTSC Red Field, No Setup

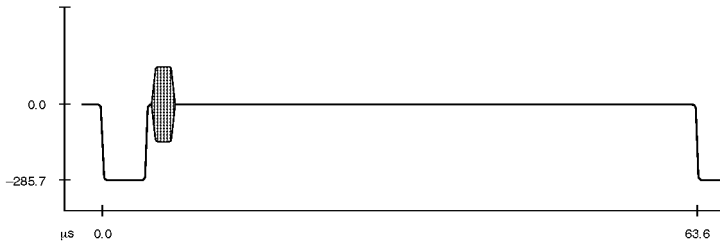

Figure 49: NTSC Black Burst, No Setup

Appendix B: Replaceable Parts

The following replaceable parts for the TSG 95 Pathfinder are available through your local Tektronix, Inc. field office or representative.

It is important when ordering parts to include the following information in your order: Part number; instrument type and number; instrument serial number; and modification number, if applicable.

Description	Tektronix Part No.
Instructions (card)	070-8915-xx
Service Manual (Optional accessory)	070-8917-xx
Rechargeable Battery Pack (Optional accessory)	119-4488-00
Carrying Pouch	016-1229-00
AC Adapter	119-4538-01*
Case Assembly, Top	614-0925-00
Case Assembly, Bottom	614-0913-00
Stand, Black Vinyl Plastic	386-6787-01
Battery Door	200-4075-00
LCD Display	119-5566-00
Rear Panel Assembly	333-4065-00
Fuse 2.0A, 125V, Slow Blow	159-0378-00

* The U.S. standard adapter. See your Tektronix representative for other adapters.

Appendix C: User Service

Battery Hints

For optimal battery life and capacity, use the rechargeable NiCad battery pack (Tektronix p/n 119-4488-00) in full charge/discharge cycles. In other words, fully discharge the battery pack before recharging, and then charge the battery pack until fully charged, approximately 16 hours. A new battery pack will take a few charge/discharge cycles to reach full capacity.



WARNING. *Install or replace batteries only with the instrument switched OFF and the AC adapter disconnected.*

Replace the batteries only with standard AA batteries (1.2–1.5 V, nominal), or with the optional rechargeable battery pack.

Setting the Auto Power Down (page 18) and Battery Type (page 19) functions in the diagnostic menu also have an impact on battery life. The battery types are disposable (Alkaline) or rechargeable (NiCad). Setting the battery type changes the voltage thresholds for both the BATTERY LOW display message and low-battery shutdown.

The BATTERY LOW Message

The warning “BATTERY LOW” will appear on the second line of the TSG 95 display when the battery voltage drops below a predetermined level. The level depends on the Battery Type set in the Diagnostic menu (see page 19). The TSG will operate for approximately ten minutes after the message first appears. For best results, replace or recharge the batteries when you first see this warning.

Low Battery Shutdown

To prevent erratic operation at very low power levels, the TSG 95 will shut itself down if the battery voltage drops below a second, lower threshold that also depends on the Battery Type setting.

Low-battery shutdown can happen with little or no warning if, for instance, the instrument has been left on by mistake with Auto Power

Down disabled. In such cases, the TSG 95 is likely to shut itself down almost immediately the next time you switch it on. If this happens:

- Install fresh batteries or operate the instrument with the AC adapter, and
- Confirm that the Utility menu Battery Type setting is appropriate.

The shutdown threshold is higher for rechargeable batteries than for disposable. Therefore, you will receive a false BATTERY LOW message and may experience premature shutdown if using Alkaline batteries when the Battery Type is set to “rechargeable.” On the other hand, NiCad batteries may be damaged—they can lose their “rechargeability”—if they are discharged to the TSG 95 threshold for disposable batteries. Be sure to select the correct Battery Type.

Preventive Maintenance

Under average conditions, the TSG 95 should receive preventive maintenance every 2000 hours. This is approximately one year of operation. Preventive maintenance includes cleaning, visual inspection, a performance check and, if necessary, calibration. See the Service manual for performance verification and adjustment procedures.



CAUTION. *The TSG 95 case is made of molded plastic. Do not allow water to get inside any enclosed assembly or component. Do not clean any plastic materials with organic cleaning solvents—benzene, toluene, xylene, acetone, or similar compounds—because they may damage the plastic.*
